

### FEATURES

- Complete rate gyroscope on a single chip
- Z-axis (yaw rate) response
- High vibration rejection over wide frequency
- 2000 g powered shock survivability
- Ratiometric to referenced supply
- 5 V single-supply operation
- 40°C to +105°C operation
- Self-test on digital command
- Ultrasmall and light (<0.15 cc, <0.5 gram)
- Temperature sensor output
- RoHS compliant
- Qualified for automotive applications

### APPLICATIONS

- Inertial measurement units
- Platform stabilization
- Robotics

### GENERAL DESCRIPTION

The ADXRS623 is a complete angular rate sensor (gyroscope) that uses the Analog Devices, Inc., surface-micromachining process to create a functionally complete and low cost angular rate sensor integrated with all required electronics on one chip. The manufacturing technique for this device is the same high volume BiMOS process used for high reliability automotive airbag accelerometers.

The output signal, RATEOUT (1B, 2A), is a voltage proportional to the angular rate about the axis that is normal to the top surface of the package. The output is ratiometric with respect to a provided reference supply. An external capacitor sets the bandwidth. Other external capacitors are required for operation.

A temperature output is provided for compensation techniques. Two digital self-test inputs electromechanically excite the sensor to test proper operation of both the sensor and the signal conditioning circuits. The ADXRS623 is available in a 7 mm × 7 mm × 3 mm ceramic ball grid array (CBGA) package.

### FUNCTIONAL BLOCK DIAGRAM

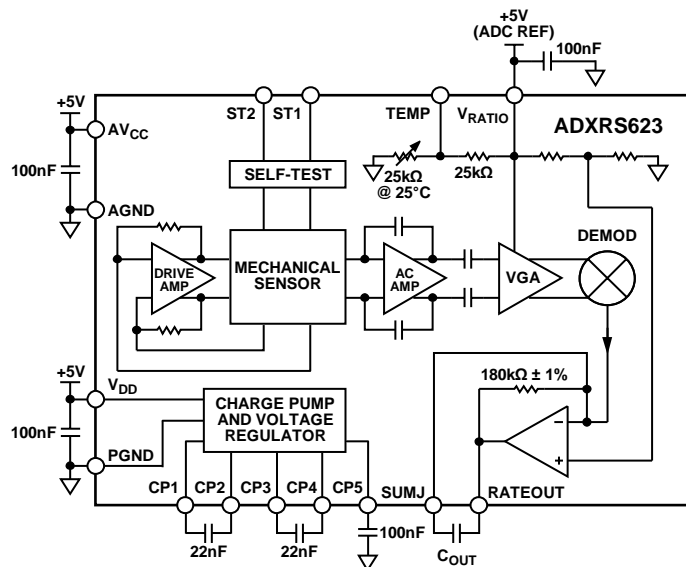

Figure 1.

#### Rev. A

Information furnished by Analog Devices is believed to be accurate and reliable. However, no responsibility is assumed by Analog Devices for its use, nor for any infringements of patents or other rights of third parties that may result from its use. Specifications subject to change without notice. No license is granted by implication or otherwise under any patent or patent rights of Analog Devices. Trademarks and registered trademarks are the property of their respective owners.

# ADXRS623\* PRODUCT PAGE QUICK LINKS

Last Content Update: 02/23/2017

---

## COMPARABLE PARTS

View a parametric search of comparable parts.

## EVALUATION KITS

- ADXRS623 Evaluation Board

## DOCUMENTATION

### Data Sheet

- ADXRS623:  $\pm 150^\circ/\text{Sec}$  Yaw Rate Gyroscope

### User Guides

- UG-151: Evaluating the ADXRS623  $\pm 150^\circ/\text{Sec}$ , Single Chip Rate Gyro

## REFERENCE MATERIALS

### White Papers

- The Five Motion Senses: MEMS Inertial Sensing to Transform Applications

## DESIGN RESOURCES

- ADXRS623 Material Declaration
- PCN-PDN Information
- Quality And Reliability
- Symbols and Footprints

## DISCUSSIONS

View all ADXRS623 EngineerZone Discussions.

## SAMPLE AND BUY

Visit the product page to see pricing options.

## TECHNICAL SUPPORT

Submit a technical question or find your regional support number.

## DOCUMENT FEEDBACK

Submit feedback for this data sheet.

---

## TABLE OF CONTENTS

Features .....	1	Theory of Operation .....	9
Applications.....	1	Setting Bandwidth.....	9
General Description .....	1	Temperature Output and Calibration.....	9
Functional Block Diagram .....	1	Calibrated Performance.....	9
Revision History .....	2	ADXRS623 and Supply Ratiometricity .....	10
Specifications.....	3	Null Adjustment .....	10
Absolute Maximum Ratings.....	4	Self-Test Function .....	10
Rate-Sensitive Axis.....	4	Continuous Self-Test.....	10
ESD Caution.....	4	Outline Dimensions .....	11
Pin Configuration and Function Descriptions.....	5	Ordering Guide .....	11
Typical Performance Characteristics .....	6	Automotive Products.....	11

## REVISION HISTORY

### 11/10—Rev. 0 to Rev. A

Change to Features .....	1
Change Operating Temperature Range, Table 2.....	4
Added Automotive Products Section.....	11

### 3/10—Revision 0: Initial Version

## SPECIFICATIONS

All minimum and maximum specifications are guaranteed. Typical specifications are not guaranteed.  $T_A = -40^{\circ}\text{C}$  to  $+105^{\circ}\text{C}$ ,  $V_S = AV_{CC} = V_{DD} = 5\text{ V}$ ,  $V_{\text{RATIO}} = AV_{CC}$ , angular rate =  $0^{\circ}/\text{sec}$ , bandwidth =  $80\text{ Hz}$  ( $C_{\text{OUT}} = 0.01\text{ }\mu\text{F}$ ),  $I_{\text{OUT}} = 100\text{ }\mu\text{A}$ ,  $\pm 1\text{ g}$ , unless otherwise noted.

**Table 1.**

Parameter	Test Conditions/Comments	Min	Typ	Max	Unit
SENSITIVITY (RATIOMETRIC) <sup>1</sup>	Clockwise rotation is positive output				
Measurement Range <sup>2</sup>	Full-scale range over specifications range	$\pm 150$			$^{\circ}/\text{sec}$
Initial and over Temperature		11.25	12.5	13.75	$\text{mV}/^{\circ}\text{sec}$
Temperature Drift <sup>3</sup>			$\pm 3$		%
Nonlinearity	Best fit straight line		0.1		% of FS
NULL (RATIOMETRIC) <sup>1</sup>					
Null	$-40^{\circ}\text{C}$ to $+105^{\circ}\text{C}$		2.5		V
Null Drift over Temperature	$-40^{\circ}\text{C}$ to $+105^{\circ}\text{C}$			$\pm 250$	mV
Linear Acceleration Effect	Any axis		0.1		$^{\circ}/\text{sec}/\text{g}$
NOISE PERFORMANCE					
Rate Noise Density	$T_A = 25^{\circ}\text{C}$		0.04		$^{\circ}/\text{sec}/\sqrt{\text{Hz}}$
FREQUENCY RESPONSE					
Bandwidth <sup>4</sup>		1		3000	Hz
Sensor Resonant Frequency			14.5		kHz
SELF-TEST (RATIOMETRIC) <sup>1</sup>					
ST1 RATEOUT Response	ST1 pin from Logic 0 to Logic 1	$-500$	$-1000$		mV
ST2 RATEOUT Response	ST2 pin from Logic 0 to Logic 1	500	1000		mV
Logic 1 Input Voltage		$0.8 \times V_{\text{RATIO}}$			V
Logic 0 Input Voltage				$0.2 \times V_{\text{RATIO}}$	V
Input Impedance	To common		50		k $\Omega$
TEMPERATURE SENSOR (RATIOMETRIC) <sup>1</sup>					
$V_{\text{OUT}}$ at $25^{\circ}\text{C}$	Load = $100\text{ M}\Omega$	2.35	2.5	2.65	V
Scale Factor <sup>5</sup>	At $25^{\circ}\text{C}$ , $V_{\text{RATIO}} = 5\text{ V}$		9.1		$\text{mV}/^{\circ}\text{C}$
Load to $V_S$			25		k $\Omega$
Load to Common			25		k $\Omega$
TURN-ON TIME	Power on to $\pm 1/2^{\circ}/\text{sec}$ of final			50	ms
OUTPUT DRIVE CAPABILITY					
Current Drive	For rated specifications			200	$\mu\text{A}$
Capacitive Load Drive				1000	pF
POWER SUPPLY					
Operating Voltage ( $V_S$ )		4.75	5.00	5.25	V
VRATIO Input		3		$V_S$	V
Supply Current			3.5	5.0	mA
TEMPERATURE RANGE					
Specified Performance		$-40$		$+105$	$^{\circ}\text{C}$

<sup>1</sup> Parameter is linearly ratiometric with  $V_{\text{RATIO}}$ .

<sup>2</sup> The maximum range possible, including output swing range, initial offset, sensitivity, offset drift, and sensitivity drift at 5 V supplies.

<sup>3</sup> From  $+25^{\circ}\text{C}$  to  $-40^{\circ}\text{C}$  or from  $+25^{\circ}\text{C}$  to  $+105^{\circ}\text{C}$ .

<sup>4</sup> Adjusted by external capacitor,  $C_{\text{OUT}}$ .

<sup>5</sup> For a change in temperature from  $25^{\circ}\text{C}$  to  $26^{\circ}\text{C}$ .  $V_{\text{TEMP}}$  is ratiometric to  $V_{\text{RATIO}}$ . See the Temperature Output and Calibration section for more details.

# ADXRS623

## ABSOLUTE MAXIMUM RATINGS

Table 2.

Parameter	Rating
Acceleration (Any Axis, 0.5 ms)	
Unpowered	2000 g
Powered	2000 g
$V_{DD}$ , $V_{CC}$	-0.3 V to +6.0 V
$V_{RATIO}$	$V_{CC}$
Output Short-Circuit Duration (Any Pin to Common)	Indefinite
Operating Temperature Range	-55°C to +125°C
Storage Temperature Range	-65°C to +150°C

Stresses above those listed under the Absolute Maximum Ratings may cause permanent damage to the device. This is a stress rating only; functional operation of the device at these or any other conditions above those indicated in the operational section of this specification is not implied. Exposure to absolute maximum rating conditions for extended periods may affect device reliability.

Drops onto hard surfaces can cause shocks of >2000 g and can exceed the absolute maximum rating of the device. Exercise care during handling to avoid damage.

## RATE-SENSITIVE AXIS

The ADXRS623 is a Z-axis, rate-sensing device (also called a yaw rate-sensing device). It produces a positive-going output voltage for clockwise rotation about the axis normal to the package top, that is, clockwise when looking down at the package lid.

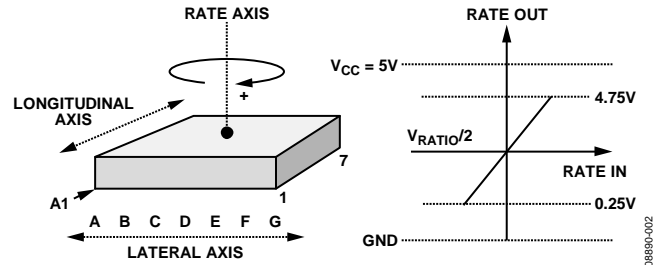

Figure 2. RATEOUT Signal Increases with Clockwise Rotation

## ESD CAUTION



**ESD (electrostatic discharge) sensitive device.** Charged devices and circuit boards can discharge without detection. Although this product features patented or proprietary protection circuitry, damage may occur on devices subjected to high energy ESD. Therefore, proper ESD precautions should be taken to avoid performance degradation or loss of functionality.

## PIN CONFIGURATION AND FUNCTION DESCRIPTIONS

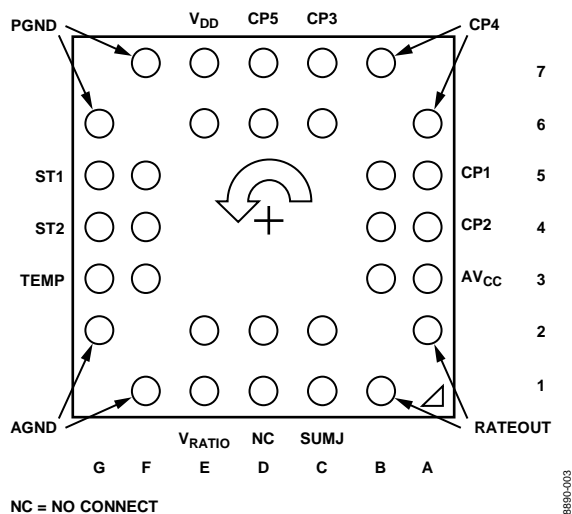

Figure 3. Pin Configuration

Table 3. Pin Function Descriptions

Pin No.	Mnemonic	Description
6D, 7D	CP5	HV Filter Capacitor (100 nF).
6A, 7B	CP4	Charge Pump Capacitor (22 nF).
6C, 7C	CP3	Charge Pump Capacitor (22 nF).
5A, 5B	CP1	Charge Pump Capacitor (22 nF).
4A, 4B	CP2	Charge Pump Capacitor (22 nF).
3A, 3B	AV <sub>CC</sub>	Positive Analog Supply.
1B, 2A	RATEOUT	Rate Signal Output.
1C, 2C	SUMJ	Output Amplifier Summing Junction.
1D, 2D	NC	No Connect.
1E, 2E	V <sub>RATIO</sub>	Reference Supply for Ratiometric Output.
1F, 2G	AGND	Analog Supply Return.
3F, 3G	TEMP	Temperature Voltage Output.
4F, 4G	ST2	Self-Test for Sensor 2.
5F, 5G	ST1	Self-Test for Sensor 1.
6G, 7F	PGND	Charge Pump Supply Return.
6E, 7E	V <sub>DD</sub>	Positive Charge Pump Supply.

## TYPICAL PERFORMANCE CHARACTERISTICS

N > 1000 for all typical performance plots, unless otherwise noted.

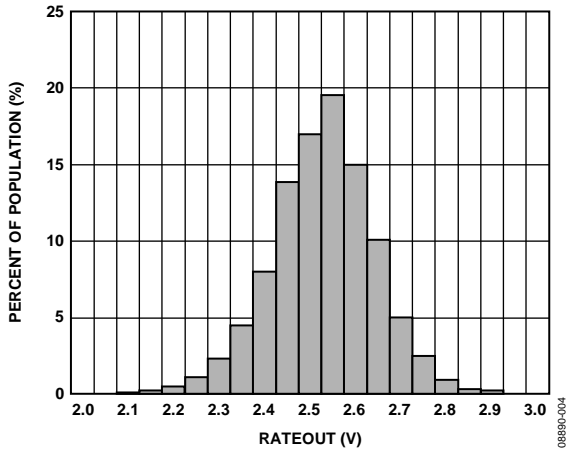

Figure 4. Null Output at 25°C ( $V_{RATIO} = 5 V$ )

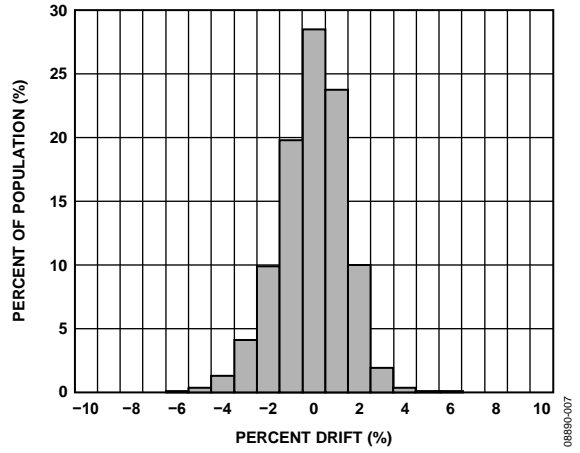

Figure 7. Sensitivity Drift over Temperature

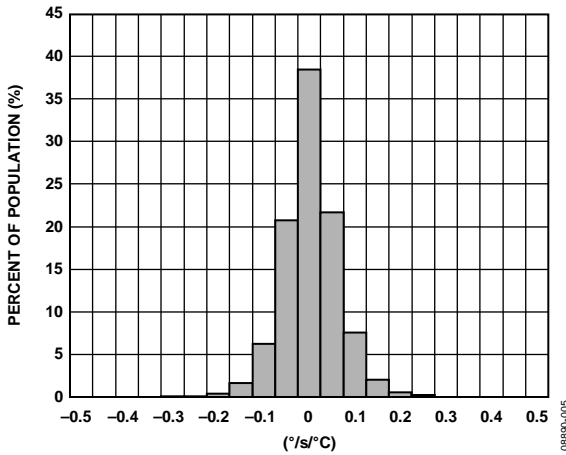

Figure 5. Null Drift over Temperature ( $V_{RATIO} = 5 V$ )

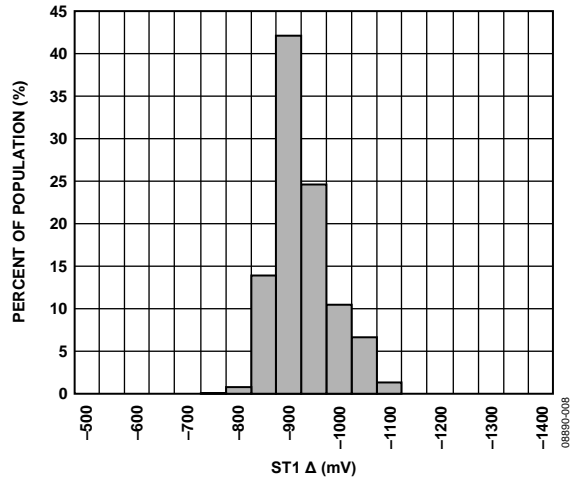

Figure 8. ST1 Output Change at 25°C ( $V_{RATIO} = 5 V$ )

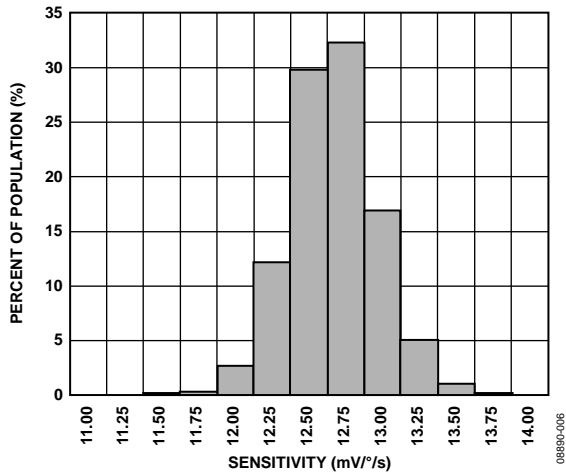

Figure 6. Sensitivity at 25°C ( $V_{RATIO} = 5 V$ )

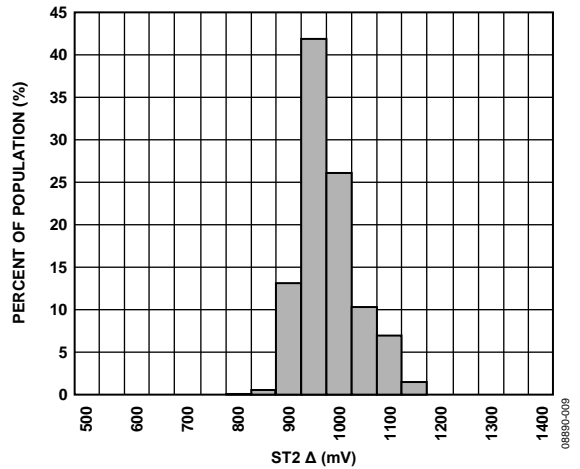

Figure 9. ST2 Output Change at 25°C ( $V_{RATIO} = 5 V$ )

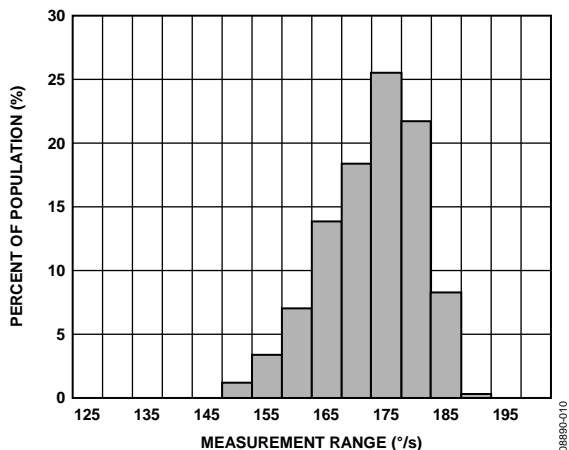

Figure 10. Measurement Range

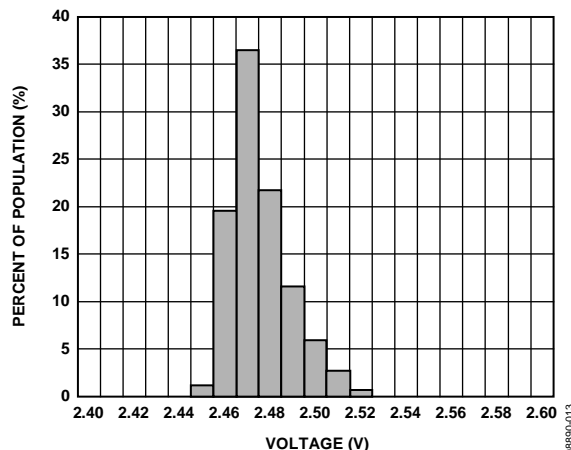

Figure 13.  $V_{TEMP}$  Output at 25°C ( $V_{RATIO} = 5 V$ )

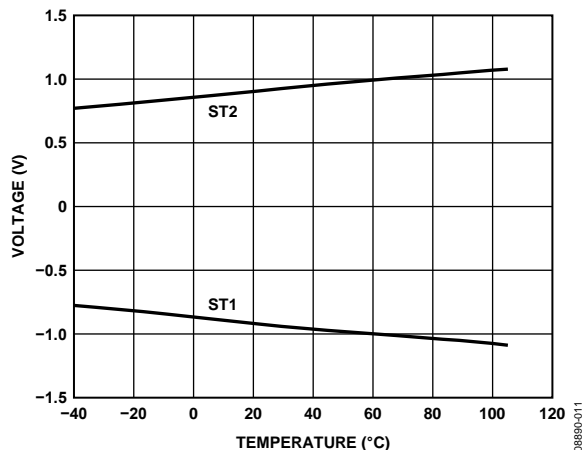

Figure 11. Typical Self-Test Change over Temperature

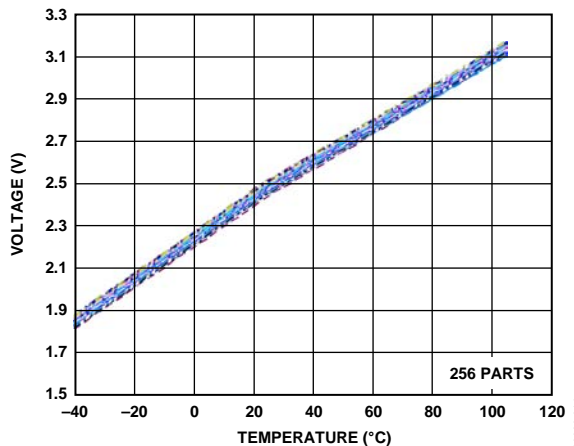

Figure 14.  $V_{TEMP}$  Output over Temperature ( $V_{RATIO} = 5 V$ )

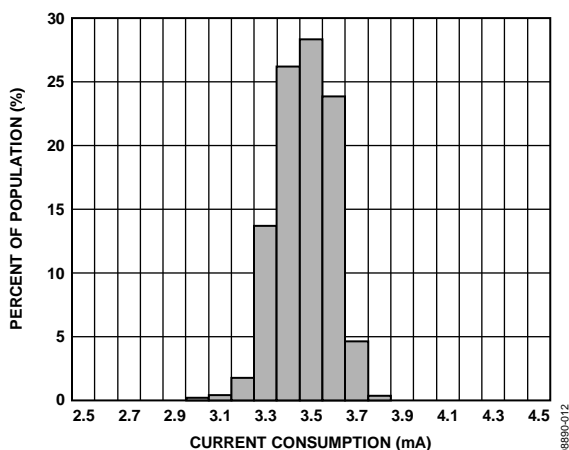

Figure 12. Current Consumption at 25°C ( $V_{RATIO} = 5 V$ )

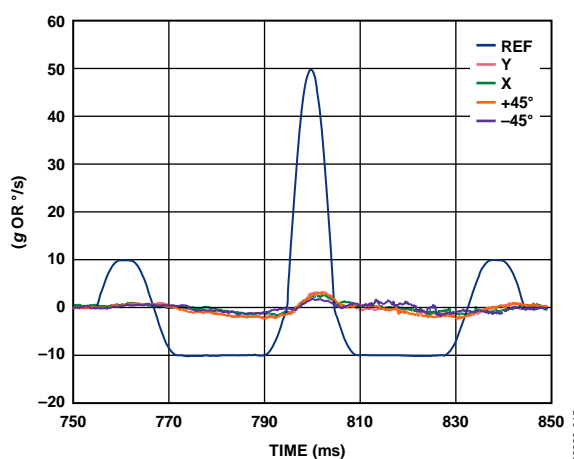

Figure 15.  $g$  and  $g \times g$  Sensitivity for a 50 g, 10 ms Pulse



# ADXRS623

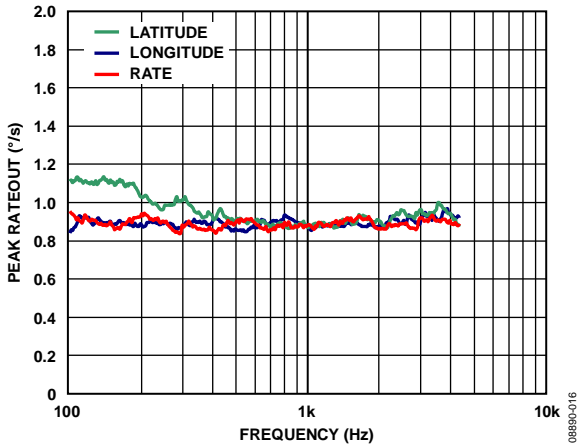

Figure 16. Typical Response to 10 g Sinusoidal Vibration (Sensor Bandwidth = 2 kHz)

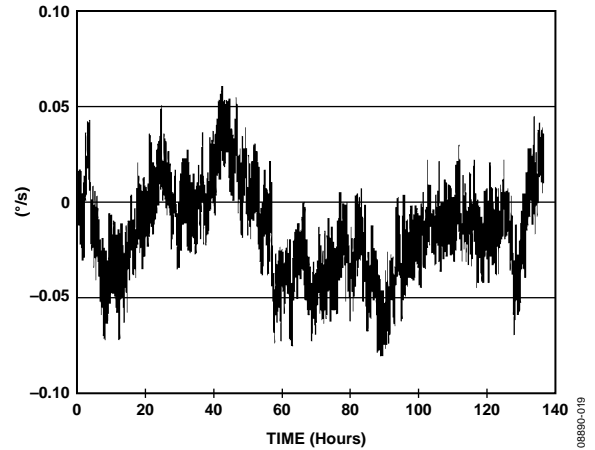

Figure 19. Typical Shift in 90 Sec Null Averages Accumulated over 140 Hours

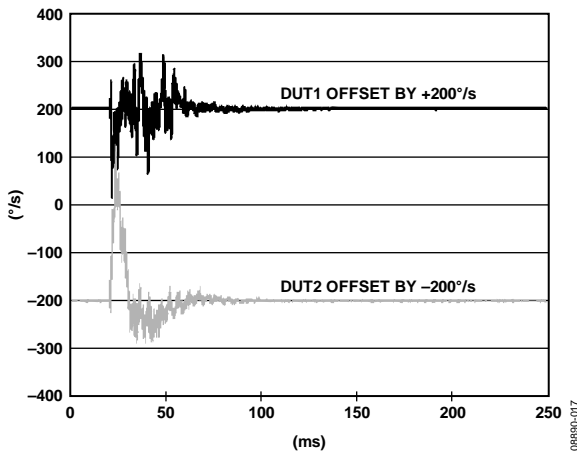

Figure 17. Typical High g (2500 g) Shock Response (Sensor Bandwidth = 40 Hz)

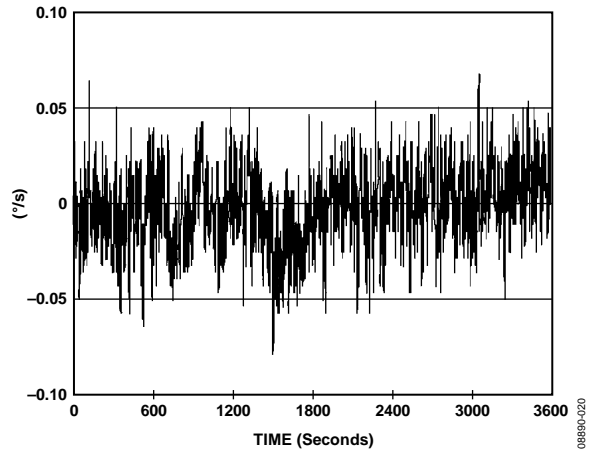

Figure 20. Typical Shift in Short-Term Null (Bandwidth = 1 Hz)

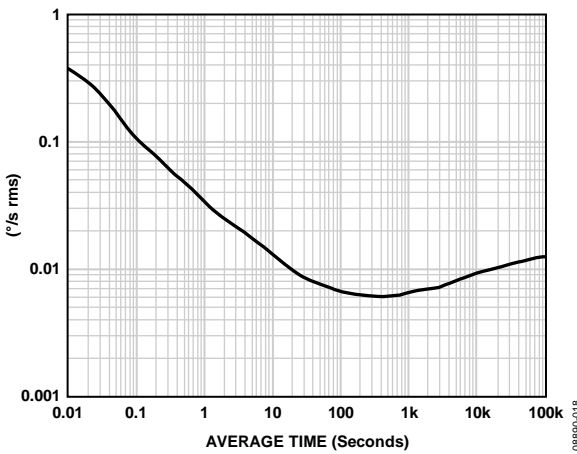

Figure 18. Typical Root Allan Deviation at 25°C vs. Averaging Time

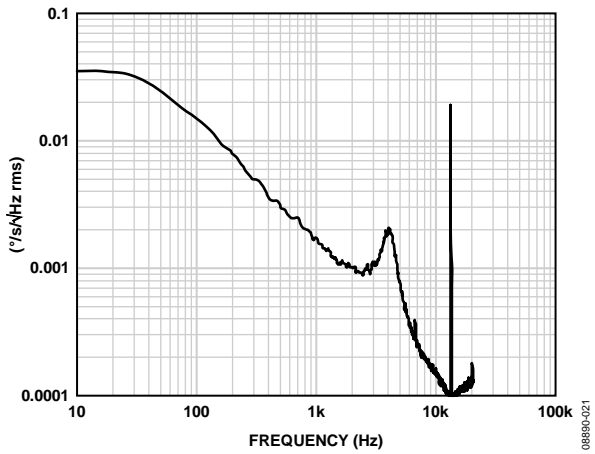

Figure 21. Typical Noise Spectral Density (Bandwidth = 40 Hz)

## THEORY OF OPERATION

The ADXRS623 operates on the principle of a resonator gyroscope. Two polysilicon sensing structures each contain a dither frame that is electrostatically driven to resonance, producing the necessary velocity element to produce a Coriolis force while rotating. At two of the outer extremes of each frame, orthogonal to the dither motion, are movable fingers that are placed between fixed pickoff fingers to form a capacitive pickoff structure that senses Coriolis motion. The resulting signal is fed to a series of gain and demodulation stages that produce the electrical rate signal output. The dual-sensor design rejects external  $g$  forces and vibration. Fabricating the sensor with signal conditioning electronics preserves signal integrity in noisy environments.

The electrostatic resonator requires 18 V to 20 V for operation. Because only 5 V are typically available in most applications, a charge pump is included on chip. If an external 18 V to 20 V supply is available, the two capacitors on CP1 through CP4 can be omitted, and this supply can be connected to the CP5 pin (6D, 7D). Note that CP5 should not be grounded when power is applied to the ADXRS623. Although no damage occurs, under certain conditions, the charge pump may fail to start up after the ground is removed without first removing power from the ADXRS623.

### SETTING BANDWIDTH

External Capacitor  $C_{OUT}$  is used in combination with the on-chip  $R_{OUT}$  resistor to create a low-pass filter to limit the bandwidth of the ADXRS623 rate response. The  $-3$  dB frequency set by  $R_{OUT}$  and  $C_{OUT}$  is

$$f_{OUT} = \frac{1}{(2 \times \pi \times R_{OUT} \times C_{OUT})}$$

and can be well controlled because  $R_{OUT}$  is trimmed during manufacturing to be  $180 \text{ k}\Omega \pm 1\%$ . Any external resistor applied between the RATEOUT pin (1B, 2A) and the SUMJ pin (1C, 2C) results in

$$R_{OUT} = \frac{(180 \text{ k}\Omega \times R_{EXT})}{(180 \text{ k}\Omega + R_{EXT})}$$

In general, an additional hardware or software filter is added to attenuate high frequency noise arising from demodulation spikes at the gyroscope's 14 kHz resonant frequency (the noise spikes at 14 kHz can be clearly seen in the power spectral density curve shown in Figure 21). Typically, the corner frequency of this additional filter is set to greater than  $5\times$  the required bandwidth to preserve good phase response.

Figure 22 shows the effect of adding a 250 Hz filter to the output of an ADXRS623 set to 40 Hz bandwidth (as shown in Figure 21). High frequency demodulation artifacts are attenuated by approximately 18 dB.

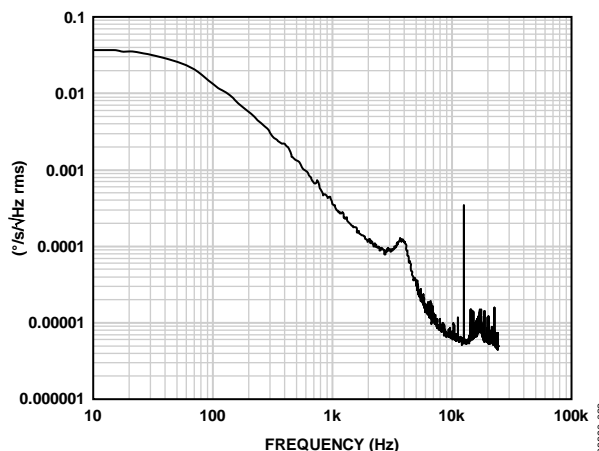

Figure 22. Noise Spectral Density with Additional 250 Hz Filter

### TEMPERATURE OUTPUT AND CALIBRATION

It is common practice to temperature-calibrate gyroscopes to improve their overall accuracy. The ADXRS623 has a temperature proportional voltage output that provides input to such a calibration method. The temperature sensor structure is shown in Figure 23. The temperature output is characteristically nonlinear, and any load resistance connected to the TEMP output results in decreasing the TEMP output and temperature coefficient. Therefore, buffering the output is recommended.

The voltage at the TEMP pin (3F, 3G) is nominally 2.5 V at 25°C and  $V_{RATIO} = 5$  V. The temperature coefficient is  $\sim 9 \text{ mV}/^\circ\text{C}$  at 25°C. Although the TEMP output is highly repeatable, it has only modest absolute accuracy.

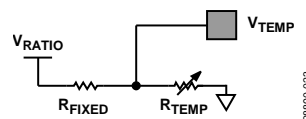

Figure 23. ADXRS623 Temperature Sensor Structure

### CALIBRATED PERFORMANCE

Using a three-point calibration technique, it is possible to calibrate the null and sensitivity drift of the ADXRS623 to an overall accuracy of nearly  $200^\circ/\text{hour}$ . An overall accuracy of  $40^\circ/\text{hour}$  or better is possible using more points.

Limiting the bandwidth of the device reduces the flat-band noise during the calibration process, improving the measurement accuracy at each calibration point.

# ADXRS623

## ADXRS623 AND SUPPLY RATIOMETRICITY

The ADXRS623 RATEOUT and TEMP signals are ratiometric to the  $V_{\text{RATIO}}$  voltage; that is, the null voltage, rate sensitivity, and temperature outputs are proportional to  $V_{\text{RATIO}}$ . Thus, the ADXRS623 is most easily used with a supply-ratiometric ADC that results in self-cancellation of errors due to minor supply variations. There is some small error due to nonratiometric behavior. Typical ratiometricity error for null, sensitivity, self-test, and temperature output is outlined in Table 4.

Note that  $V_{\text{RATIO}}$  must never be greater than  $AV_{\text{CC}}$ .

**Table 4. Ratiometricity Error for Various Parameters**

Parameter	$V_s = V_{\text{RATIO}} = 4.85 \text{ V}$	$V_s = V_{\text{RATIO}} = 5.15 \text{ V}$
ST1		
Mean	0.3%	0.09%
Sigma	0.21%	0.19%
ST2		
Mean	-0.15%	-0.2%
Sigma	0.22%	0.2%
Null		
Mean	-0.3%	-0.05%
Sigma	0.2%	0.08%
Sensitivity		
Mean	0.003%	-0.25%
Sigma	0.06%	0.06%
$V_{\text{TEMP}}$		
Mean	-0.2%	-0.04%
Sigma	0.05%	0.06%

## NULL ADJUSTMENT

The nominal 2.5 V null is for a symmetrical swing range at RATEOUT (1B, 2A). However, a nonsymmetrical output swing may be suitable in some applications. Null adjustment is possible by injecting a suitable current to SUMJ (1C, 2C). Note that supply disturbances may reflect some null instability. Digital supply noise should be avoided, particularly in this case.

## SELF-TEST FUNCTION

The ADXRS623 includes a self-test feature that actuates each of the sensing structures and associated electronics as if subjected to angular rate. It is activated by standard logic high levels applied to Input ST1 (5F, 5G), Input ST2 (4F, 4G), or both. ST1 causes the voltage at RATEOUT to change about -1.0 V, and ST2 causes an opposite change of +1.0 V. The self-test response follows the viscosity temperature dependence of the package atmosphere, approximately 0.25%/°C.

Activating both ST1 and ST2 simultaneously is not damaging. ST1 and ST2 are fairly closely matched ( $\pm 5\%$ ), but actuating both simultaneously may result in a small apparent null bias shift proportional to the degree of self-test mismatch.

ST1 and ST2 are activated by applying a voltage of greater than  $0.8 \times V_{\text{RATIO}}$  to the ST1 and ST2 pins. ST1 and ST2 are deactivated by applying a voltage of less than  $0.2 \times V_{\text{RATIO}}$  to the ST1 and ST2 pins. The voltage applied to ST1 and ST2 must never be greater than  $AV_{\text{CC}}$ .

## CONTINUOUS SELF-TEST

The one-chip integration of the ADXRS623 gives it higher reliability than is obtainable with any other high volume manufacturing method. In addition, it is manufactured under a mature BiMOS process with field-proven reliability. As an additional failure detection measure, a power-on self-test can be performed. However, some applications may warrant continuous self-test while sensing rate. Details about continuous self-test techniques are available in the AN-768 Application Note, *Using the ADXRS150/ADXRS300 in Continuous Self-Test Mode*, available at [www.analog.com](http://www.analog.com).

## OUTLINE DIMENSIONS

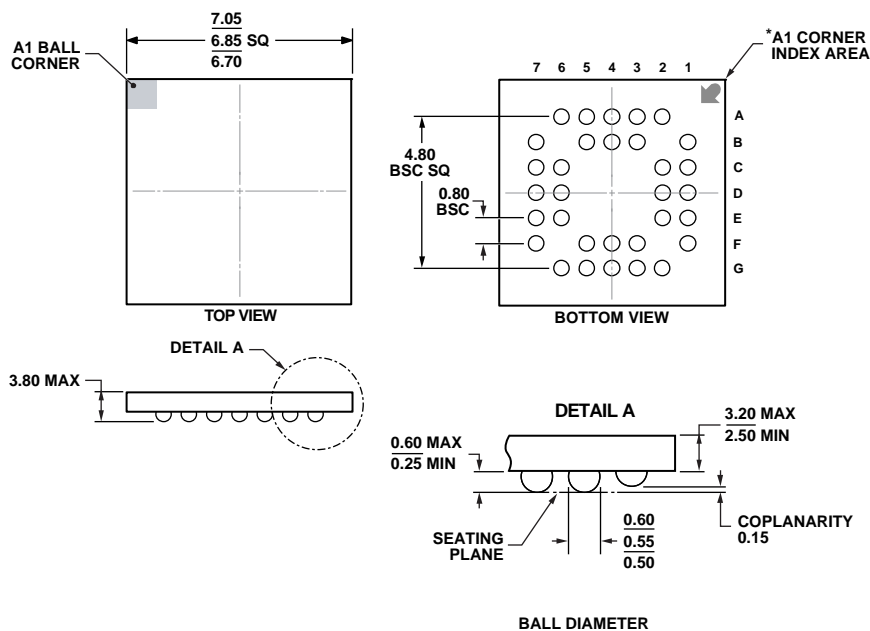

\*BALL A1 IDENTIFIER IS GOLD PLATED AND CONNECTED TO THE D/A PAD INTERNALLY VIA HOLES.

Figure 24. 32-Lead Ceramic Ball Grid Array [CBGA] (BG-32-3)

Dimensions shown in millimeters

10-26-2009-B

## ORDERING GUIDE

Model <sup>1,2</sup>	Temperature Range	Package Description	Package Option
ADXRS623BBGZ	-40°C to +105°C	32-Lead Ceramic Ball Grid Array (CBGA)	BG-32-3
ADXRS623BBGZ-RL	-40°C to +105°C	32-Lead Ceramic Ball Grid Array (CBGA)	BG-32-3
ADXRS623WBBGZ	-40°C to +105°C	32-Lead Ceramic Ball Grid Array (CBGA)	BG-32-3
ADXRS623WBBGZ-RL	-40°C to +105°C	32-Lead Ceramic Ball Grid Array (CBGA)	BG-32-3
EVAL-ADXRS623Z		Evaluation Board	

<sup>1</sup> Z = RoHS Compliant Part.

<sup>2</sup> W = Qualified for Automotive Applications.

## AUTOMOTIVE PRODUCTS

The ADXRS623W models are available with controlled manufacturing to support the quality and reliability requirements of automotive applications. Note that these automotive models may have specifications that differ from the commercial models; therefore, designers should review the Specifications section of this data sheet carefully. Only the automotive grade products shown are available for use in automotive applications. Contact your local Analog Devices account representative for specific product ordering information and to obtain the specific Automotive Reliability reports for these models.

**ADXRS623**

**NOTES**