User Manual for the

SM150

Soil Moisture Sensor



Delta-T Devices Ltd

Notices

Copyright

All parts of the SM150 design and documentation are the exclusive right of Delta-T Devices and covered under copyright law.
Copyright © 2014 Delta-T Devices Ltd.

Patents

The SM150 is protected under international law by the following patents:-

USA: Patent US7944220

Europe: Patent EP1836483

Australia: Patent AU2005315407

China: Patent Application CN101080631

EMC Compliance

See page 35.

Design changes

Delta-T Devices Ltd reserves the right to change the designs and specifications of its products at any time without prior notice.

User Manual Version: SM150-UM-1.1

Apr 2014



Delta-T Devices Ltd
130 Low Road, Burwell
Cambridge CB25 0EJ
UK

Tel: +44 1638 742922
Fax: +44 1638 743155
email: sales@delta-t.co.uk
web: www.delta-t.co.uk

Contents

Introduction	5
Description	5
Features	5
Dimensions	6
Parts list	7
Care and Safety	8
How the SM150 works	9
Operation	10
Cable Connections	10
Installation	11
HH150 Meter	12
HH2 Meter	13
Logger connections and configuration	14
GP1 Logger	14
GP2 Logger Controller	15
DL6 Logger	16
DL2e Logger	17
Other data loggers	18
Logger Grounding	19
Calibration	22
Soil calibration	23
Sensor calibration	25
Soil moisture reading	26
Troubleshooting	28

Technical Reference	30
Specifications	30
Definitions	36
References	38
Appendix 1	39
Soil-specific Calibration	39
Laboratory calibration for non-clay soils	40
Laboratory calibration for clay soils	43
Technical Support	46
Index	48

Introduction

Description

The *SM150* measures soil moisture content.

Its sealed plastic body is attached to two sensing rods which insert directly into the soil for taking readings.

A waterproof plug connects to a choice of signal cables.

Both extension cables and extension tubes can be used.

The soil moisture output signal is a differential analogue DC voltage. This is converted to soil moisture by a data logger or meter using the supplied general soil calibrations.

It can also be calibrated for specific soils.

Features

- Soil moisture accurate to $\pm 3\%$
- Low salinity sensitivity
- Excellent stability
- Minimal soil disturbance
- Easy installation at depth in augured holes
- Waterproof connector to IP68
- Rugged, weather-proof and can be buried.
- Good electrical immunity
- Choice of cabling system options
- Cable connector, cylindrical profile and extension tube design simplifies removal for servicing
- Dedicated HH150 meter kit for simple readings
- HH2 meter, GP1, GP2, DL6 and DL2e loggers compatible

See also **Specifications** on page 30



Dimensions









Cable connector sealed to IP68
M12, 5 pin, male

Thread 3/4inch BSP
for connecting to
Extension Tube(s)



Parts list

Your shipment may include the following:

	HH150 soil moisture sensor
	HH150 +SM150 Kit
	HH150 includes 1m cable, Connects to SM150
	SMCS/d-HH2 0.9m cable Connects SM150 to HH2
	SMSC/sw-05 5m cable 100mm flying leads Connect to GP1,GP2 & DL6
	SMSC/lw-05 5m cable 200mm flying leads Connect to DL2 data logger
	Logger extension cables EXT/5W-05 5m EXT/5W-10 10m EXT/5W-25 25m
	Extension tubes ML/EX50 50cm ML/EX100 100cm
	SM-AUG-100 Spiral Auger 1.2m

Care and Safety

- The rods of the SM150 are sharp in order to ease insertion. Care must be taken and handling precautions followed.
- Avoid touching the rods or exposing them to other sources of static charge, particularly when powered up. Keep the SM150 in its protective tube when not in use.
- Take care when attaching cables to ensure that the connectors are clean, undamaged and properly aligned *before* pushing the parts together.
- Do not pull the SM150 out of the soil by its cable.
- If you feel strong resistance when inserting the SM150 into soil, it is likely you have encountered a stone. Stop pushing and re-insert at a new location.
- Do not touch the pins, particularly when the sensor is attached to a cable. An electrostatic discharge from your body can typically cause a temporary -10mV offset in sensor readings for up to one hour. At worst it may permanently damage the sensor.

To prevent personal injury and damage to the probe always store and transport the SM150 in this protective tube

CAUTION
SHARP PINS



How the SM150 works

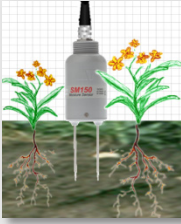

When power is applied to the *SM150*...



...it creates a 100MHz waveform (similar to FM radio).



The waveform is applied to a pair of stainless steel rods which transmit an electromagnetic field into the soil.

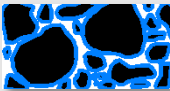

The water content of the soil surrounding the rods...

ϵ

...dominates its **permittivity**.

(A measure of a material's response to polarisation in an electromagnetic field. Water has a permittivity ≈ 81 , compared to soil ≈ 4 and air ≈ 1)

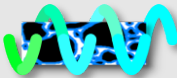

The permittivity of the soil has a strong influence on the applied field...

V_{out}





...which is detected by the SM150, resulting in a stable voltage output that...

soil moisture
22 %

...acts as a simple, sensitive measure of **soil moisture content**.

Operation

Cable Connections

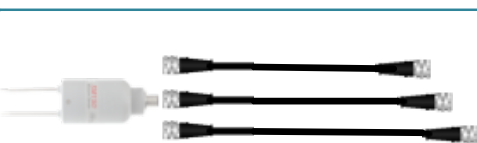
	HH150 includes 1m cable, Connects to SM150
	SMCS/d-HH2 0.9m cable Connects SM150 to HH2
	SMSC/sw-05 5m cable 100mm flying leads Connect to GP1,GP2 & DL6
	SMSC/lw-05 5m cable 200mm flying leads Connect to DL2 data logger
	Logger extension cables EXT/5W-05 5m EXT/5W-10 10m EXT/5W-25 25m

See also **Logger connections and configuration** page 14

- Take care when attaching cables to ensure that the connectors are clean, undamaged and properly aligned **before** pushing the parts together.
- Screw together firmly to ensure the connection is water-tight.
- Extension cables* can be joined up to a recommended maximum of 100m (for GP1, DL6 or DL2e data loggers) – see **Specifications** on page 30.

*Note: for full accuracy, do not use extension cables with the HH150.

Installation

Surface installation and spot measurements

- Clear away any stones. Pre-form holes in very hard soils before insertion.
- Push the SM150 into the soil until the rods are fully inserted. Ensure good soil contact.
- If you feel strong resistance when inserting the SM150, you have probably hit a stone. Stop, and re-insert at a new location.



Installing at depth

- Make a 45mm diameter hole, preferably at about 10° to the vertical using the **SM-AUG-100** auger.
- Connect an extension tube e.g. **ML/EX50**
- Push the SM150 into the soil until rods are fully inserted. Ensure good soil contact.



Alternatively

- Dig a trench, and install horizontally.

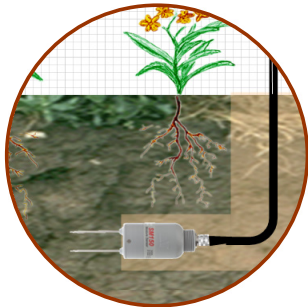

HH150 Meter

- Connect the SM150 to the HH150 meter.
- With the meter OFF, press the right **off – menu** button. This wakes and allows you to set the meter to display readings - as % volumetric water content of either Mineral, Peat Mix, Coir, Mineral Wool or Perlite soils, or to show the sensor output in Volts.
- Press off to save the current Setting and turn the meter off.
- With the meter off, press the left **on – read** button to take a reading.



Repeat as required. You may wish to write down the readings.

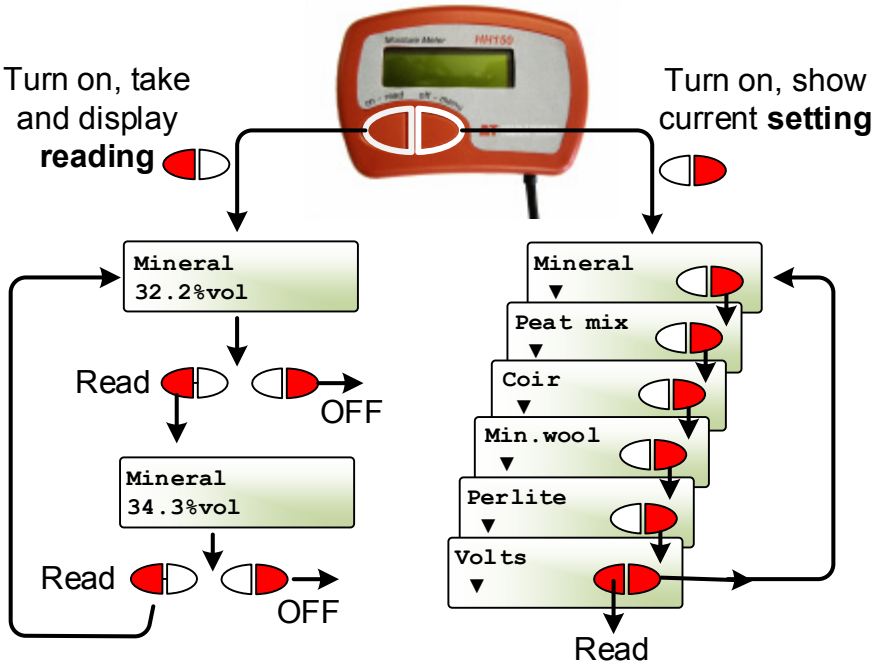

HH2 Meter

This assumes you have version 2.6 or later for both the PC software HH2Read and the HH2 firmware (see foot of page).



- Connect the SM150 to the HH2 meter.
- Press **Esc** to turn the meter on, and if necessary press again until the HH2 displays the start-up screen.
- Set the meter to read from an SM150:
 - ▶ Press **Set** and scroll down to the **Device** option.
 - ▶ Press **Set** again and scroll down to select SM150.
 - ▶ Press **Set** to confirm this choice.



- Make sure the HH2 is correctly configured for your soil type:
 - ▶ At the start-up screen, press **Set** and scroll down to the **Soil Type** option.
 - ▶ Press **Set** again and scroll down to the appropriate soil type (use **Mineral** for sand, silt or clay soils or **Organic** for peaty soils)
 - ▶ Press **Set** to confirm this choice.

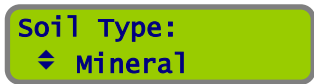

- Choose the units you want for displaying readings.
 - ▶ At the start-up screen, press **Set** and scroll down to the **Display** option.
 - ▶ Press **Set** again and scroll down to select units.
 - ▶ Press **Set** to confirm this choice.

- Press **Read** to take a reading.
- Press **Store** to save or **Esc** to discard the reading.



- Remove the SM150 from the soil and move to a new location...
- If you have saved data, connect your HH2 to a PC and run **HH2Read** to retrieve the readings.



For an upgrade contact Delta-T.

See also: **HH2 User Manual** and

HH2 User Manual Addendum to V4 – SM150 Support.

Logger connections and configuration

GP1 Logger

4 SM150s can be connected, but channels 3 and 4 are less accurate and can cause noise problems.

Requirements

GP1 logger (with v1.47 firmware or later)
PC running DeltaLINK (version 2.6 or later)
SM150 with SMSC/sw-05 cable



Channel 1 and 2 wiring

SM150 wire	Colour	GP1 terminal
Power 0V	brown	CH1/2 (GND)
Power V+	white	CH1/2 (PWR)
Signal HI	blue	CH1/2 (+)
Signal LO	black	CH1/2 (-)
Cable shield	green	CH1/2 (GND)
Not used	grey	Not connected

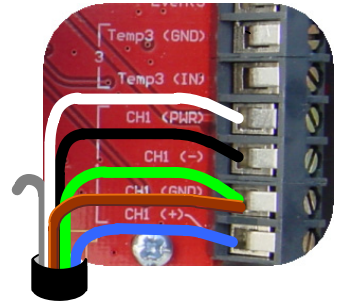

Channel 3 and 4 wiring

SM150 wire	Colour	GP1 terminal
Power 0V	brown	CH1/2 (GND) or WET GND
Power V+	white	CH1/2 (PWR) or WET PWR
Signal HI	blue	Temp3/4 (IN)
Signal LO	black	Temp3/4 (GND)
Cable shield	green	Temp3/4 (GND) or WET GND
Not used	grey	Not connected

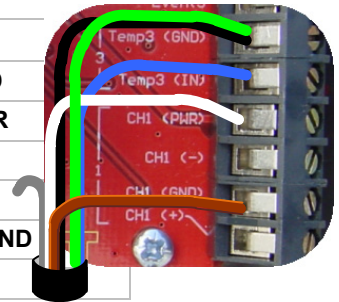

- In the DeltaLINK sensor menu configure each sensor type **SM150**.







Note: channels 1&2 are wired differently to 3&4. Note also that the relative positions of the terminals change on the left and right sides of the GP1

See also **GP1 Quick Start Guide** and the DeltaLINK on-line Help.

GP2 Logger Controller

Up to 12 SM150s can connect to a GP2.
If using more than 9 you need expansion lid **GP2-G5-LID**.

These details illustrate connection to Channels 1:

<i>SM150 wire</i>		<i>Colour</i>	<i>GP2 terminal</i>
Power 0V		brown	CH1 (PGND)
Power V+		white	CH1 (PWR)
Soil Moisture Signal HI		blue	CH1 (+)
Soil Moisture Signal LO		black	CH1 (-)
Cable shield		green	CH1 (PGND)
Not used		grey	Not connected

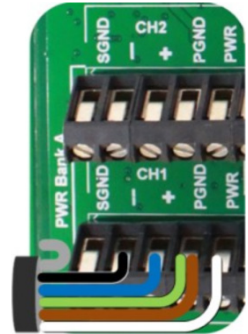







For configuration details see the **DeltaLINK** software sensor **Info Panel** and **Help** or the **GP2 User Manual**.

DL6 Logger

6 SM150s can be connected to a DL6.
Each is wired as a differential, powered sensor.

These details illustrate connection to channel 6

<i>SM150 wire</i>		<i>Colour</i>	<i>DL6 terminal</i>
Power 0V		brown	0V
Power V+		white	V+
Signal HI		blue	IN+
Signal LO		black	IN-
Cable shield		green	<i>///</i>
Not used		grey	Not connected

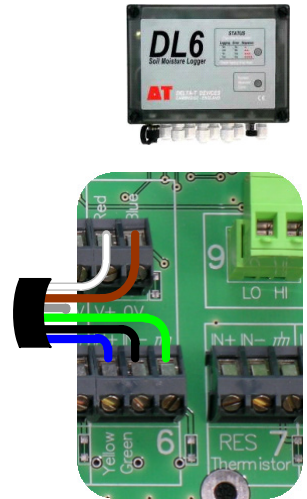

In DeltaLINK¹ configure channel 6 as type **SM150**.





See also the **DL6 Quick Start Guide** and the DeltaLINK online Help.

¹ You need the PC logger software DeltaLINK version 2.6 or later obtainable online at www.delta-t.co.uk or from the **Software and Manuals DVD**

DL2e Logger

Up to 60 SM150s can be connected to a DL2e. Each moisture sensor is connected as a differential, powered sensor.

These details illustrate connection to channel 58 using a **LAC1** input card configured in 15-channel mode, and warm-up channel 63:

<i>SM150 wire</i>		<i>Colour</i>	<i>DL2e terminal</i>
Power 0V		brown	CH62- or 61-
Power V+		white	CH63 NO
Signal HI		blue	CH58+
Signal LO		black	CH58-
Cable shield		green	CH61- or 62-
Not used		grey	Not connected

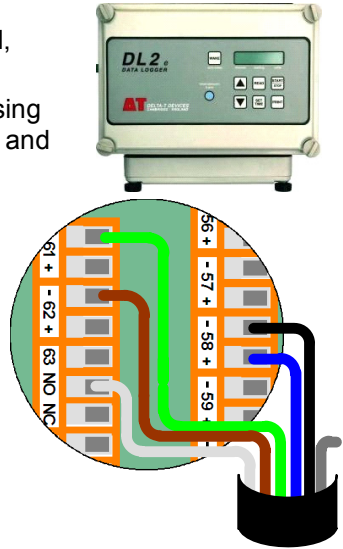

Note: If using channel 58 ensure the **LAC1** card ribbon is attached to the connector block opposite terminal groups 46-60. See page 3 of **DL2e Quick Start Guide**.

Configure the chosen DL2e logger channels by selecting the appropriate **S1M** and **S1O** sensor types for mineral and organic soils listed in the Ls2Win² sensor library.

See also the **DL2e User Manual** and the **Ls2Win** online help

² You need a PC running Ls2Win version 1.0 SR8 or later. A free upgrade can be obtained from www.delta-t.co.uk or from the **Software and manuals DVD**.

Other data loggers

- The SM150 soil moisture output should be connected as a differential, powered sensor.
- Configure the logger to convert the SM150 readings from milliVolts into soil moisture units by using either :-
Polynomial conversion on page 26 or
Linearisation table conversion on page 27

Note: Output signals in the range 0 to 1.0 volts from the SM150, corresponding to ~0 to 60% water content in mineral soils – see **Linearisation table conversion** on page 27.

Note: The SM150 has been optimised for warm-up of 0.5 to 1 second duration. It is recommended that the sensor is not powered continuously.

Logger Grounding

Sub-optimal grounding of a DC power supply and its cabling to a logger can cause currents in the screen of the cable connected to a soil moisture sensor, and so cause corrosion at the M12 connector of an SM150 soil moisture sensor. In addition, if used in an electrically noisy environment - such as a farm or greenhouse - then the presence of a ground loop can permit AC signals to inject noise and so disrupt readings.

To minimise sensor cable-screen currents that can result from the DC power supply unit and its cabling to the logger, earth the logger using a 1m long copper-clad earth stake.



Figure 1 Showing the use of a 1m long copper-clad earth rod connected to logger earth

Ungrounded system

In the example shown in Figure 2 both the logger and the power supply are not grounded, so a current loop can exist between the sensor and the mains power source, allowing noise to be injected into readings, and also galvanic corrosion to the M12 connector on the SM150.

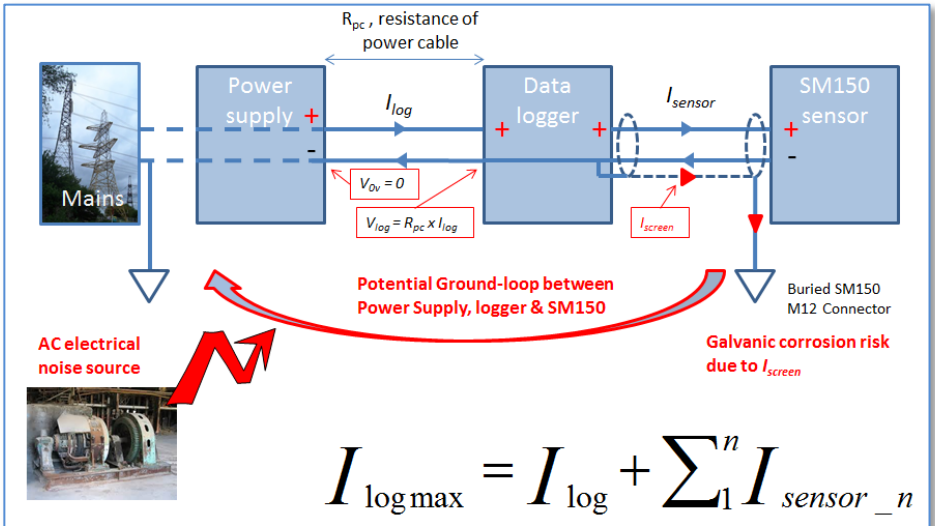

Figure 2 This diagrams shows that if the logger is are not well grounded then a potential ground loop can exist between the sensor and the power supply and/or mains power, and also the risk of galvanic corrosion to buried M12 connectors on the sensor and cable.

Fully grounded system

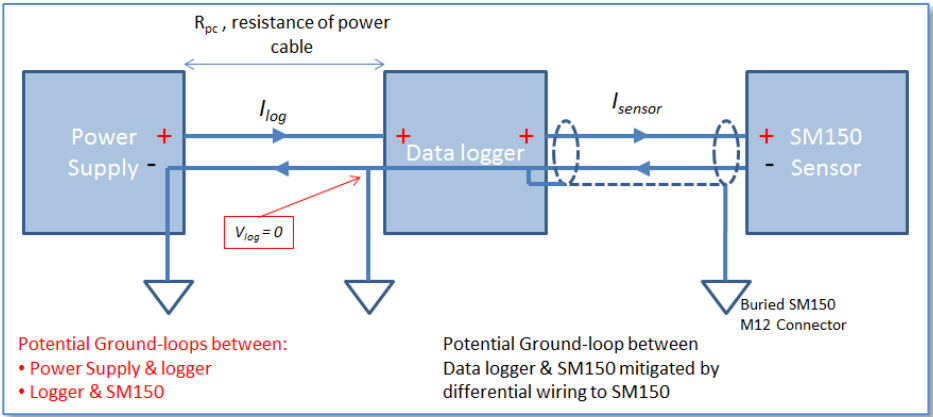

Figure 3 This diagram shows the logger, power supply and sensor all grounded. This minimises the possibility of galvanic corrosion of the SM150 connector. It also minimises the possibility of nearby AC-powered machinery injecting noise into the readings. The potential ground loop between logger and sensor is mitigated by the differential wiring of the SM150

Logger grounded

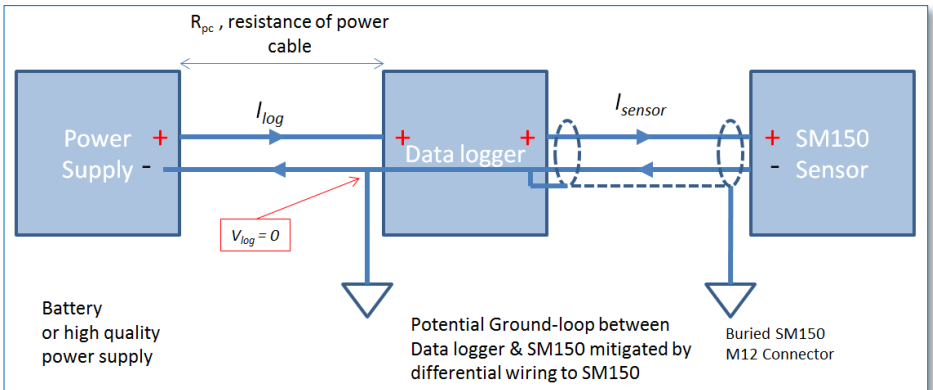

Figure 4 This diagram shows a battery or high quality power supply with no leakage current to ground. The logger is grounded. The potential ground loop between logger and sensor is mitigated by the differential wiring of the SM150. This is the best arrangement.

Calibration

The SM150 is provided with general calibrations for **mineral** and **organic** soils which can be used to convert the output from the sensor directly into soil moisture when used with Delta-T loggers and moisture meters. This section explains how these calibrations work, how to adapt them for other soils and how to provide calibrations for other data loggers.

The SM150 measures volumetric soil moisture θ , by detecting the dielectric properties of the damp soil – the permittivity, ϵ , or more conveniently the **refractive index**, which is closely equivalent to $\sqrt{\epsilon}$.

The SM150 response is best understood in these stages:

1. Soil calibration

$$\theta \rightarrow \sqrt{\epsilon}$$

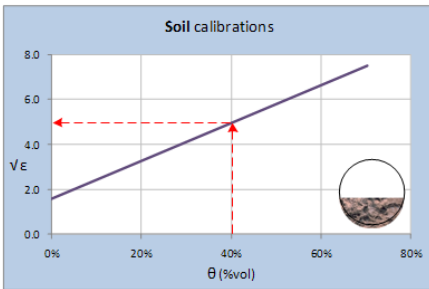

2. Sensor calibration

$$V \rightarrow \sqrt{\epsilon}$$

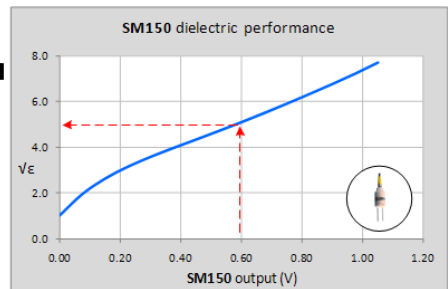

3. Soil moisture reading

$$V \rightarrow \theta$$

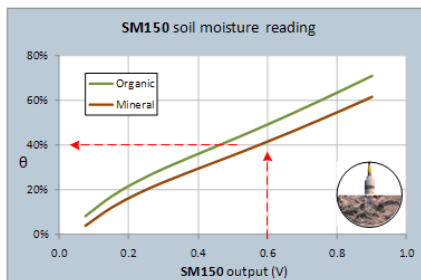

Soil calibration

Damp soil is essentially a mixture of soil particles, air and water, and together these components determine its dielectric properties, including the refractive index $\sqrt{\epsilon}$. The refractive index of the mixture is approximated simply by adding the contributions from the individual components [ref 4.].

For a particular soil, the contribution from the soil particles can be assumed to be constant, so the refractive index measured by the SM150 is only affected by changes to the water content, θ . This relationship simplifies to:

$$\sqrt{\epsilon} = a_0 + a_1 \cdot \theta$$

where the coefficients a_0 and a_1 conveniently parameterise the dielectric properties of soils.

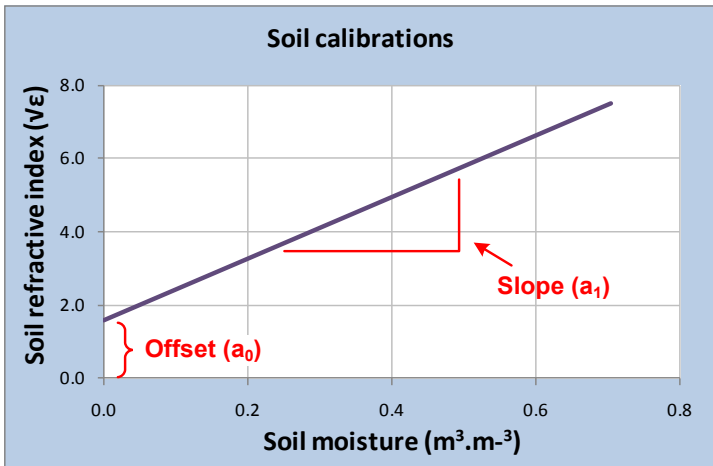

Note that:

$a_0 = \sqrt{\epsilon_{dry_soil}}$ is usually between 1.3 to 2.3

a_1 corresponds approximately to $\sqrt{\epsilon_{water}} - 1$ and usually takes a value about 8.0. Real soil values for a_0 and a_1 can vary significantly from these guidelines when they are affected by other factors – in particular, bound water in clay may result in higher values of a_1 .

General soil calibrations

Most soils can be characterised simply by choosing one of the two general calibrations we supply, one for mineral soils (predominantly sand, silt and clay) and one for organic soils (with a high organic matter content).

	a_0	a_1
Mineral soils	1.6	8.4
Organic soils	1.3	7.7

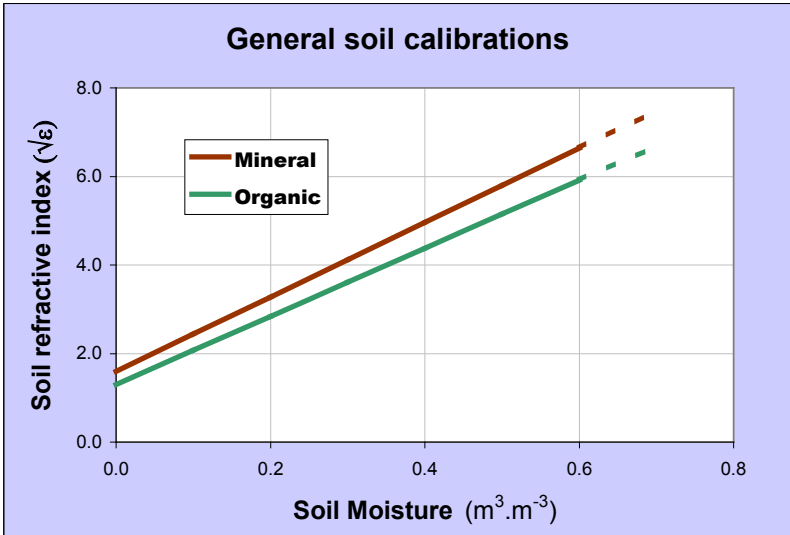

These values have been used to generate the polynomial conversions and linearisation tables in the **Soil moisture reading** section.

Soil-specific calibration

Instead of adopting these general calibrations, you may wish to determine specific calibration values of a_0 and a_1 for your soil. This procedure is fairly straightforward if you can get access to standard laboratory equipment and is described in detail in Appendix 1 on page 39.

Soil specific calibration can significantly improve the accuracy of individual readings - but make less of an improvement to readings where installation and sampling errors are high.

Sensor calibration

Each SM150 is individually adjusted to provide consistent dielectric performance:

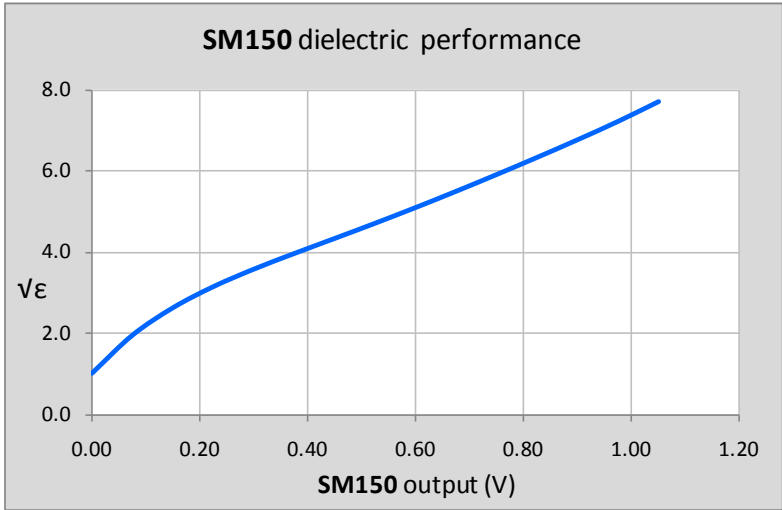

This response can be approximated either by a polynomial (below) or by a linearisation table (see next page):

Polynomial (for use over the full range of SM300 readings)

$$\sqrt{\epsilon} = 1.0 + 14.4396V - 31.2587V^2 + 49.0575V^3 - 36.5575V^4 + 10.7117V^5$$

where V is the SM150 output in Volts

Linearisation table

(for use over the full range of SM150 readings)

V	$\sqrt{\varepsilon}$	V	$\sqrt{\varepsilon}$	V	$\sqrt{\varepsilon}$	V	$\sqrt{\varepsilon}$	V	$\sqrt{\varepsilon}$
0.000	1.000	0.300	3.576	0.600	5.101	0.900	6.778	1.200	8.924
0.075	1.942	0.375	3.964	0.675	5.503	0.975	7.232	1.275	9.743
0.150	2.620	0.450	4.337	0.750	5.917	1.050	7.720	1.350	10.808
0.225	3.144	0.525	4.713	0.825	6.342	1.125	8.270	1.425	12.242

Soil moisture reading

Polynomial conversion

Combining the **Soil calibrations** and **Sensor calibration** steps, the conversion equation becomes:

$$\theta = \frac{[1.0 + 14.4396V - 31.2587V^2 + 49.0575V^3 - 36.5575V^4 + 10.7117V^5] - a_0}{a_1}$$

where a_0 and a_1 are the calibration coefficients

For a generalised **mineral** soil this becomes:

$$\theta_{\text{mineral}} = -0.0714 + 1.7190V - 3.7213V^2 + 5.8402V^3 - 4.3521V^4 + 1.2752V^5$$

And for a generalised **organic** soil:

$$\theta_{\text{organic}} = -0.0390 + 1.8753V - 4.0596V^2 + 6.3711V^3 - 4.7477V^4 + 1.3911V^5$$

Linearisation table conversion

The conversion from SM150 reading (Volts) to soil moisture θ ($\text{m}^3 \cdot \text{m}^{-3}$ or %vol) can be accomplished by a look-up table.

The following table lists the values used for the DL2e data logger:

<i>Soil moisture</i>	<i>Mineral soil</i>	<i>Organic soil</i>	<i>Soil moisture</i>	<i>Mineral soil</i>	<i>Organic soil</i>
<i>%vol</i>	<i>Volts</i>	<i>Volts</i>	<i>%vol</i>	<i>Volts</i>	<i>Volts</i>
-4	-2.090	-2.090	52	0.758	0.638
0	0.046	0.022	56	0.818	0.695
4	0.076	0.046	60	0.876	0.750
8	0.110	0.074	64	0.933	0.805
12	0.149	0.105	68	0.987	0.859
16	0.195	0.140	72	1.039	0.910
20	0.248	0.180	76	1.087	0.962
24	0.308	0.226	80	1.130	1.010
28	0.373	0.279	84	1.170	1.056
32	0.440	0.336	88	1.206	1.099
36	0.507	0.397	92	1.238	1.138
40	0.573	0.458	96	1.267	1.174
44	0.636	0.520	100	1.294	1.207
48	0.699	0.580	104	2.090	2.090

Troubleshooting

Always try to identify which part of the measurement system is the source of the difficulty. For the *SM150* this may fall into one of the following areas:

The measurement device

What equipment is being used to read the probe output?

- An HH150 or HH2 Moisture Meter.
- A data logger such as the GP1, GP2, DL6 or DL2e

Check Versions

Check you have the correct versions:

HH2 Meter: Firmware version 2.6 or later and PC software HH2Read version 2.6 or later are recommended.

GP1, GP2 & DL6 Loggers: DeltaLINK version 3.0 or later is required.

DL2e Logger: Ls2Win 1.0 SR8 or later is required

Consult the user manuals or the on-line help for these devices and their related software.

Try alternative types of equipment if you have them available.

Check that you are using an appropriate soil calibration and the correct conversion method – see **Calibration** section.

The SM150 itself

Try to isolate the problem into one of the following areas

- The SM150 or the connecting cable

Then try to narrow down the area further

- Mechanical problems faults, or damage
- Electrical or electronic problems or faults

Functional check

Air reading

Hold the SM150 in air and away from other objects and take a reading using an HH150 or HH2 meter or voltmeter or a logger with no more than 5m of cable.

Warning: Do not touch the pins

A typical electrostatic discharge from your body can create a temporary -10mV offset in sensor readings lasting an hour.

In air an SM150 gives an output of $0 \pm 4\text{mV}$.

Note: the HH150 reports under-range if the reading is less than zero.



Water reading

Immerse the pins in water and measure the output in volts.

In the UK the sensor will typically read about 1.5 volts in tap water (because the salinity is typically $50\text{mS}\cdot\text{m}^{-1}$).

The “water reading” will depend on the salinity of your local water.

Note: HH150 meter indicates “TOO WET” above 1.5V or 85% vol.

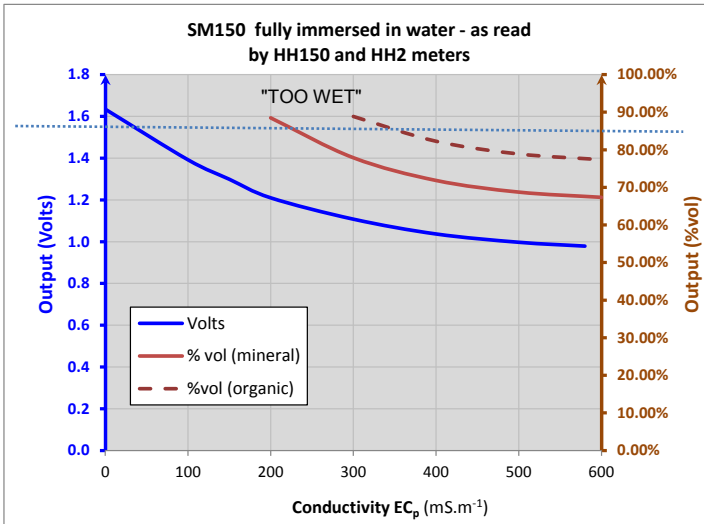

Soil moisture readings are not correct when no soil is present i.e. at 100% vol.

SM150 tables and polynomial constants are optimised at $220\text{mS}\cdot\text{m}^{-1}$ for soil moisture values below 70%vol

Graph: showing the effect of salinity on SM150 sensor output when fully immersed in water with no soil present.

Technical Reference

Specifications

Accuracy	±3.0% vol over 0 to 70 % vol and 0-60°C
Measurement range	0 to 100% vol but less accurate above 70%vol ³
Salinity error	±5% vol over 100 to 1000 mS.m ⁻¹ and 0-60% vol
Conductivity response	See page 31
Temperature sensitivity	See page 32
Sampling volume	See page 33
Output signal	0-1 V differential ≈ 0 to 60% nominal
Output compatible with	HH150, HH2, GP1, GP2, DL6, DL2e
Maximum cable length	1m (HH150 meter) 100m (GP1, GP2, DL6 and DL2e data loggers)
Power requirement	5-14VDC, 18mA for 1s
Operating range	-20 to +60°C
Environment	IP68 ⁴
Sample volume	55 x 70mm diameter
Dimensions/Weight	143 x 40 mm diameter/ 0.1 kg

³ In water (no soil present) the reading may not be 100% vol. It depends on a0 and a1 but can still be used as a quick check that the unit is working. See also page 25

⁴ With Delta-T supplied cables

Conductivity response

This chart shows how salinity affects the output of the soil moisture sensor at various soil moisture levels.

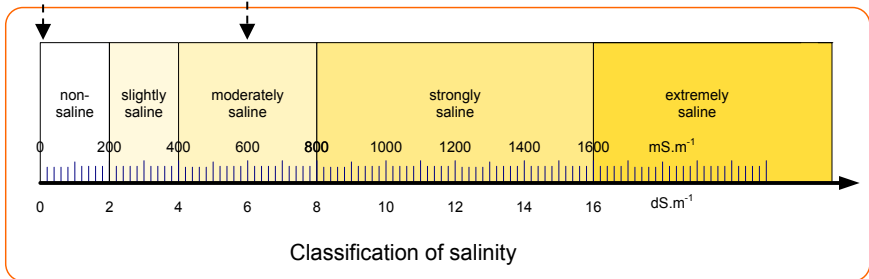
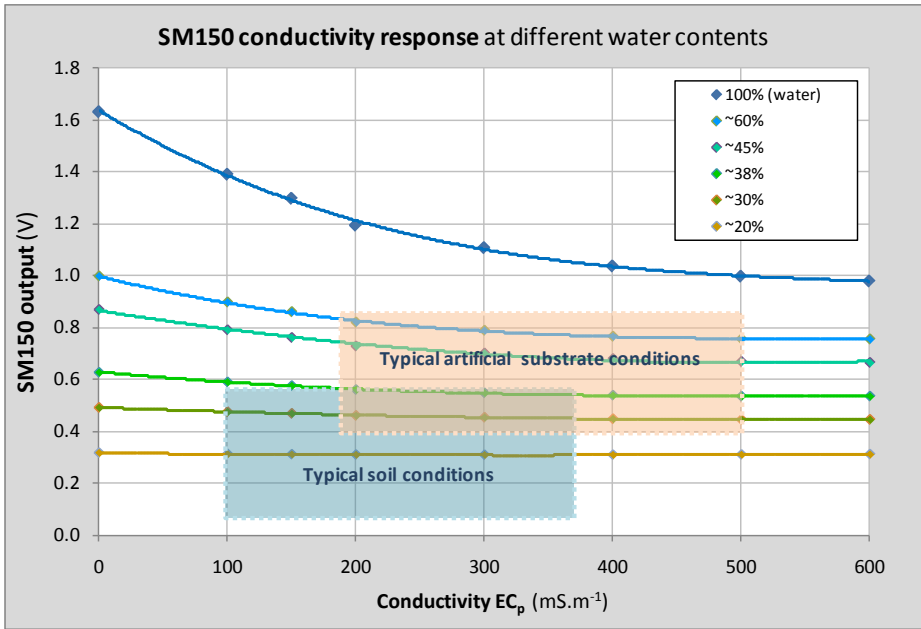

Temperature response of soil moisture readings

The effect of temperature on the SM150 soil moisture readings in any particular soil will depend on a combination of effects:

- The SM150 soil moisture electronics has very low temperature sensitivity, and makes a negligible contribution to the overall sensitivity.
- The refractive index of water ($\sqrt{\epsilon}$, see **Calibration** section) reduces as the temperature increases. This produces a negative temperature response particularly in soils or substrates with high water content.
- Water that is bound to the surface of soil particles has a much lower refractive index than free water. The percentage of bound water decreases with temperature and this produces a positive temperature response particularly in clay soils at lower water contents.

The last two effects partially offset each other, but in soil conditions where one or the other effect dominates, the SM150 will appear to have a significant temperature response. This illustration is based on the model in reference 7, see page 38.

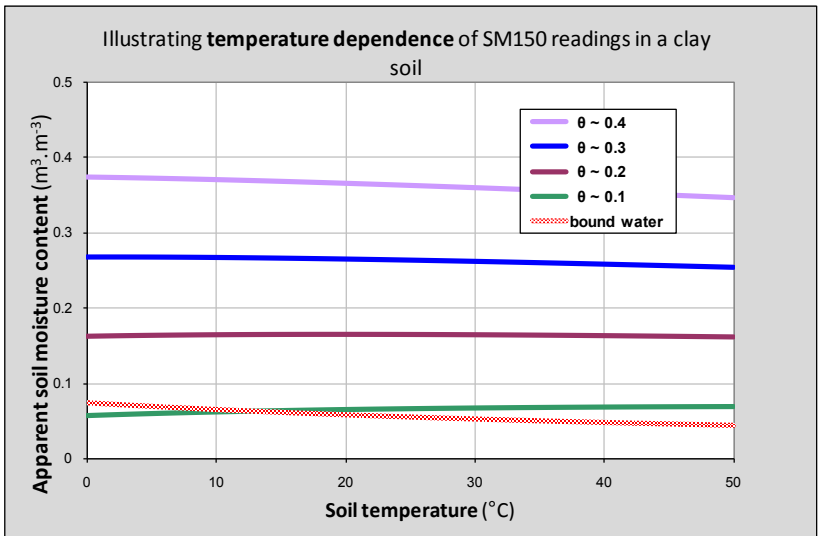

Note: ice has a quite different refractive index from water, so SM150 soil moisture readings cannot be interpreted reliably when inserted into soil below 0°C.

Sampling Volume

The SM150 is most sensitive to signals very close to the two rods, but a small proportion of the signal reaches up to 50mm from the rods.

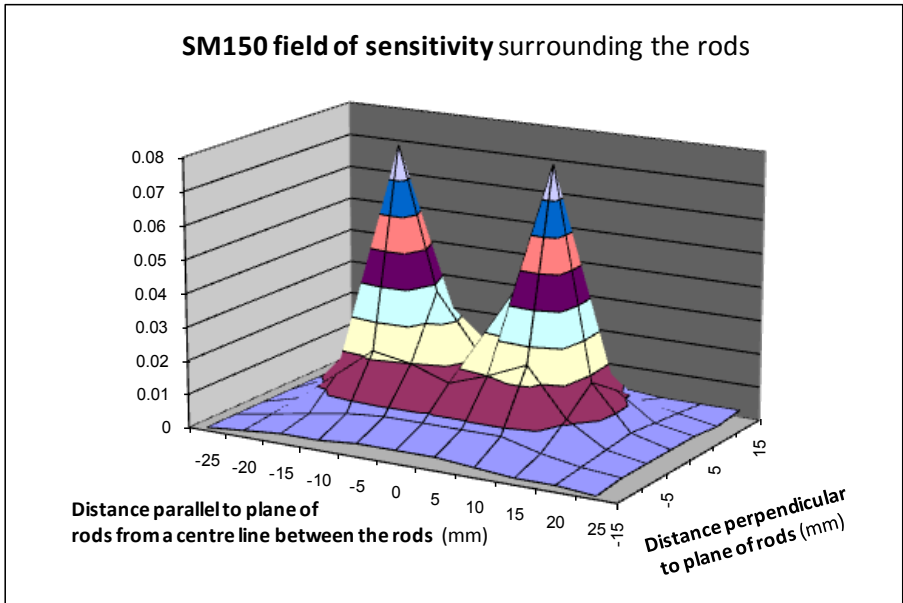

Minimum soil sample size: Full accuracy requires a soil volume of one litre but the additional error from taking a reading in a 0.5 litre sample is negligible

SM150s may interact if they are placed too close together – they should be separated by at least 100mm.

If the SM150 is inserted too close to the wall of a plant pot the sensing field can “see” outside the pot. This behaviour is shown in the graph below.

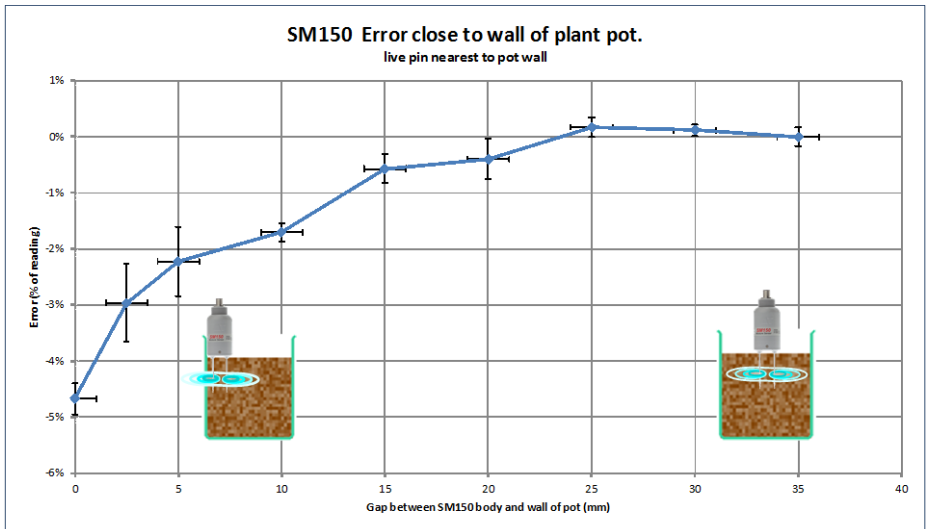

For best results keep a gap of at least 25mm (1 inch) between the body of the sensor and the wall of the plant pot.

Electromagnetic Compatibility (EMC)

General information

SM150 is a Class A product, intended for operation in non-residential environments.

Only use cables and accessories authorised by Delta-T (sensor cables from other sources for example may adversely affect product performance and affect quality of results).

If possible route cables along the soil surface or bury them – this also reduces possible trip hazard and animal damage.

Do not modify the product or its supplied accessories.

See also **SM150 EMC Guidance** on the Software and Manuals CD Issue 5

Regulatory information

Europe

This device conforms to the essential requirements of the EMC directive 2004/108/EC, based on the following test standards:

EN61326-1:2006 Electrical requirement for measurement, control and laboratory use. EMC requirements: Group 1, Class A equipment – (emissions section only).

EN61326-1:2006 Electrical requirement for measurement, control and laboratory use. EMC requirements: Basic Immunity (immunity section only).

FCC compliance (USA)

This device conforms to Part 18 of FCC rules – Industrial, Scientific & Medical Equipment.

Note: with reference to FCC Part 18.115 Elimination and investigation of harmful interference.

(a) The operator of the ISM equipment that causes harmful interference to radio services shall promptly take appropriate measures to correct the problem.

Definitions

Volumetric Soil Moisture Content is defined as

$$\theta_V = \frac{V_W}{V_S}$$

where V_W is the volume of water contained in the sample
and V_S is the total volume of the soil sample.

The preferred units for this ratio are $\text{m}^3 \cdot \text{m}^{-3}$, though **%vol** is frequently used.

Soil Moisture Content varies from approx. $0.02 \text{ m}^3 \cdot \text{m}^{-3}$ for sandy soils at the permanent wilting point, through approx. $0.4 \text{ m}^3 \cdot \text{m}^{-3}$ for clay soils at their field capacity, up to values as high as $0.85 \text{ m}^3 \cdot \text{m}^{-3}$ in saturated peat soils.

Gravimetric Soil Moisture Content is defined as

$$\theta_G = \frac{M_W}{M_S} \text{ g.g}^{-1}$$

where M_W is the mass of water in the sample,
and M_S is the total mass of the **dry** sample.

To convert from volumetric to gravimetric water content, use the equation

$$\theta_G = \theta_V \times \frac{\rho_W}{\rho_S}$$

where ρ_W is the density of water ($= 1 \text{ g.cm}^{-3}$),
and ρ_S is the bulk density of the sample ($\frac{M_S}{V_S}$).

Organic and Mineral soil definitions:

The general calibrations have been optimised to cover a wide range of soil types, based on the following definitions:

Soil type	optimised around organic content:	use for organic contents:	bulk density range: (g.cm ⁻³)	use for bulk densities: (g.cm ⁻³)
Mineral	~ 1 %C*	< 7 %C	1.25 - 1.5	> 1.0
Organic	~ 40 %C	> 7 %C	0.2 - 0.7	< 1.0

* Note: %C denotes "percentage Carbon" and is a measure of organic content

Salinity

The preferred SI units for ionic conductivity are **mS.m⁻¹** (where S is Siemens, the unit of electric conductance. Dimensionally it is equivalent to the inverse of resistance i.e. Ohm⁻¹).

The following conversions apply:

$$\begin{aligned}
 1 \text{ mS.m}^{-1} &= 0.01 \text{ dS.m}^{-1} \\
 &= 0.01 \text{ mS.cm}^{-1} \\
 &= 10 \text{ }\mu\text{S.cm}^{-1}
 \end{aligned}$$

Soil salinity can be classified using the following descriptive categories:

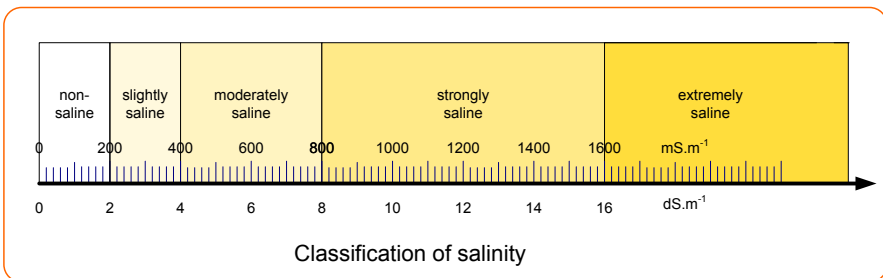

See also http://www.land.vic.gov.au/DPI/Vro/vrosite.nsf/pages/water_spotting_soil_salting_class_ranges#s1

References

1. Gaskin, G.J. and J.D. Miller, 1996
Measurement of soil water content using a simplified impedance measuring technique.
J. Agr. Engng Res **63**, 153-160
2. Topp, G.C., J. L. Davis and A. P Annan 1980
Electromagnetic determination of soil water content.
Water Resour. Res **16**(3) 574-582
3. Whalley, W.R. 1993
Considerations on the use of time-domain reflectometry (TDR) for measuring soil moisture content.
Journal of Soil Sci. **44**, 1-9
4. White, I., J.H. Knight, S.J. Zegelin, and Topp, G.C. 1994
Comments on 'Considerations on the use of time-domain reflectometry (TDR) for measuring soil water content' by W R Whalley
Journal of Soil Sci. **45**, 503-508
5. Roth, C.H., M.A. Malicki, and R. Plagge, 1992
Empirical evaluation of the relationship between soil dielectric constant and volumetric water content as the basis for calibrating soil moisture measurements.
Journal of Soil Sci. **43**, 1-13
6. Knight, J.H. 1992
Sensitivity of Time Domain Reflectometry measurements to lateral variations in soil water content.
Water Resour. Res., **28**, 2345-2352
7. Or, D. and J.M. Wraith 1999
Temperature effects on soil bulk dielectric permittivity measured by time domain reflectometry: A physical model.
Water Resour Res., **35**, 371-383

Appendix 1

Soil-specific Calibration

This note provides details of 2 techniques for generating soil-specific calibrations:

Laboratory calibration for substrates* and non-clay soils

Laboratory calibration for clay soils

* We use the term *substrate* to refer to any artificial growing medium.

Underlying principle

Soil moisture content (θ) is proportional to the refractive index of the soil ($\sqrt{\varepsilon}$) as measured by the SM150 (see **Calibration** section).

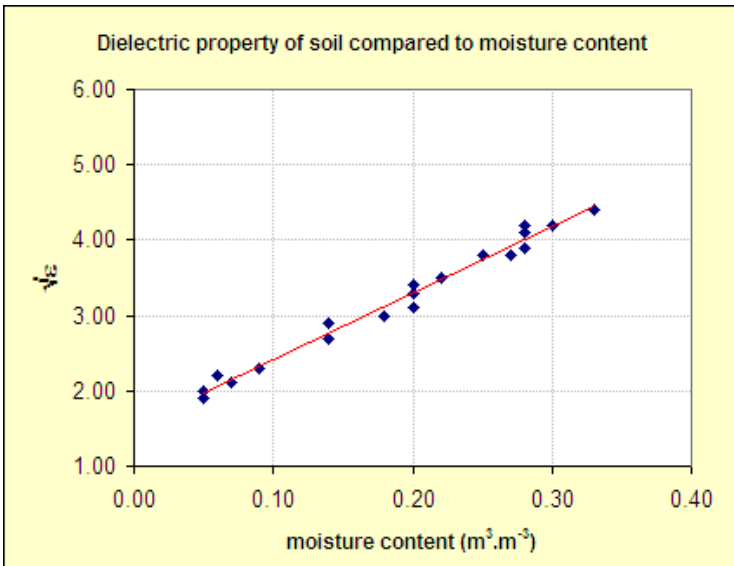

The goal of calibration is to generate two coefficients (a_0 , a_1) which can be used in a linear equation to convert probe readings into soil moisture:

$$\sqrt{\varepsilon} = a_0 + a_1 \times \theta$$

Laboratory calibration for non-clay soils

This is the easiest technique, but it's not suitable for soils that shrink or become very hard when dry.

Equipment you will need:

- SM150 and meter
- Soil corer (if doing a calibration for a cohesive soil rather than sand or a substrate)
- Heat-resistant beaker (≥ 0.5 litre)
- Weighing balance (accurate to < 1 g)
- Temperature controlled oven (for mineral soils or substrates)

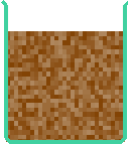
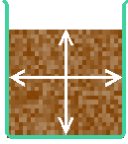
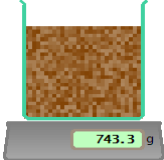
<i>Process</i>	<i>Notes and example</i>
	<p>Collect a damp sample of the soil or substrate.</p> <p>This sample needs to be unchanged from its in-situ density, to be ≥ 0.5 litre, to have the correct dimensions to fit the beaker, and to be generally uniform in water content.</p> <p>For cohesive soils this is most easily done with a soil-corer.</p> <p>Sandy soils can be poured into the beaker, but you should take the subsequent measurements immediately, as the water will quickly begin to drain to the bottom of the beaker.</p> <p>Compressible soils and composts often require measurement of the in-situ density and then need to be carefully reconstituted at that density within the beaker.</p>
	<p>Measure the volume occupied by the sample.</p> <p>$L_s = 463.5\text{ml}$</p>
	<p>Weigh the sample, including the beaker.</p> <p>$W_w = 743.3\text{g}$</p>



Insert SM150 into the sample and record its output in Volts.

$$V_w = 0.350V$$

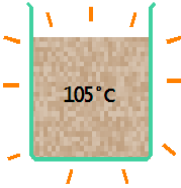

Dry the sample thoroughly.

With mineral soils this is usually achieved by keeping it in the oven at 105°C for several hours or days (the time required depends on the sample size and porosity).

For organic soils and composts it's usual to air-dry the sample to avoid burning off any volatile fractions.

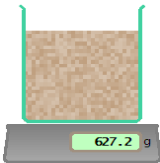

Weigh the dry sample in the beaker.

$$W_0 = 627.2g$$



Re-insert the SM150 into the dry sample and record this reading.

$$V_0 = 0.051V$$

Calculate α_0

For the SM150,

In the dry soil $V = V_0 = 0.051$ Volts

Substitute this into the equation

$$\sqrt{\epsilon} = 1.0 + 14.4396V - 31.2587V^2 + 49.0575V^3 - 36.5575V^4 + 10.7117V^5$$

gives $\sqrt{\epsilon} = 1.66$

Since $\theta_0 = 0$, this is the value needed for α_0

$$\alpha_0 = 1.66$$

Calculate θ_w

The water content of the wet soil, θ_w , can be calculated from the weight of water lost during drying, $(W_w - W_0)$ and its

	volume, L_s : $\theta_w = (W_w - W_0)/L_s = (743.3 - 627.2)/463.5 = 0.25$ $\theta_w = 0.25$
Calculate a_1	In the wet soil $V = V_w = 0.350$ Volts and substituting gives $\sqrt{\varepsilon_w} = 3.79$ Finally $a_1 = (\sqrt{\varepsilon_w} - \sqrt{\varepsilon_0})/(\theta_w - \theta_0) = (3.79 - 1.66)/(0.25 - 0) = 8.51$ $a_1 = 8.51$
Result	$a_0 = 1.66$ $a_1 = 8.51$

In this example this soil is now calibrated.

You can now use these two numbers in place of the standard mineral or organic calibration factors to convert SM150 readings into volumetric water content θ using:

$$\sqrt{\varepsilon} = a_0 + a_1 \times \theta$$

See also page [Underlying principle](#) on page 39

Laboratory calibration for clay soils

This technique is adapted to avoid the near-impossibility of inserting the SM150 into completely dry clay soil. It requires taking measurements at 2 significantly different, but still damp, moisture levels.

Equipment you will need:

- SM150 and meter
- Soil corer
- Heat-resistant beaker ($\geq 500\text{ml}$)
- Weighing balance (accurate to $< 1\text{g}$)
- Temperature controlled oven

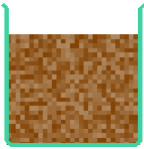
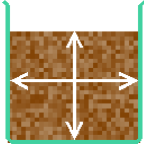
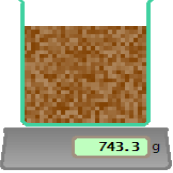
<i>Process</i>	<i>Notes and example</i>
	<p>Collect a <u>wet</u> sample of the clay soil: 25 to 30% water content would be ideal.</p> <p>This sample needs to be unchanged from its in-situ density, to be $\geq 500\text{ml}$, to have the correct dimensions to fit the beaker, and to be generally uniform in water content.</p> <p>This is most easily done with soil-corer.</p>
	<p>Measure the volume occupied by the sample.</p> <p>$L_s = 463.5\text{ml}$</p>
	<p>Weigh the wet sample, including the beaker.</p> <p>$W_w = 743.3\text{g}$</p>

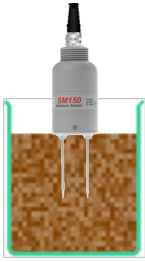

Insert SM150 into the wet sample and record its output in Volts.

$$V_w = 0.349V$$

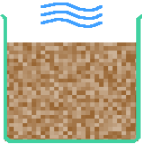

Dry the sample until still moist, ~15% water content. Gentle warming can be used to accelerate the process, but take care not to over-dry in places, and allow time for the water content to equilibrate throughout the sample before taking a reading.

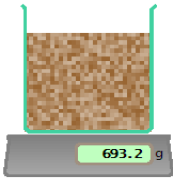

Reweigh.

$$W_m = 693.2g$$



Re-measure with the SM150.

$$V_m = 0.180V$$

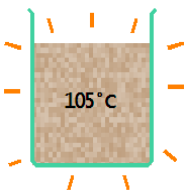

Dry the sample thoroughly.

With clay soils this is usually achieved by keeping it in the oven at 105°C for several hours or days (the time required depends on the sample size and porosity).

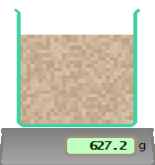

Weigh the dry sample in the beaker.

$$W_o = 627.2g$$

Calculations	<p>Substituting in the SM150 equation</p> $\sqrt{\epsilon} = 1.0 + 14.4396V - 31.2587V^2 + 49.0575V^3 - 36.5575V^4 + 10.7117V^5$ <p>provides two dielectric values, $\sqrt{\epsilon_w}$ and $\sqrt{\epsilon_m}$, at two known water contents, θ_w and θ_m</p>
For the wet soil	<p>Substituting $V_w = 0.349$ gives</p> $\sqrt{\epsilon_w} = 3.83 = a_0 + a_1 \cdot \theta$ <p>for $\theta_w = \frac{(743.3 - 627.2)}{463.5} = 0.25$</p>
For the moist soil	<p>Substituting $V_m = 0.180$ gives</p> $\sqrt{\epsilon_m} = 2.84 = a_0 + a_1 \cdot \theta$ <p>for $\theta_m = \frac{(693.2 - 627.2)}{463.5} = 0.14$</p>
Calculate a_1	<p>Then $a_1 = \frac{\sqrt{\epsilon_w} - \sqrt{\epsilon_m}}{\theta_w - \theta_m} = 9.0$</p> <p>$a_1 = 9.00$</p>
Calculate a_0	<p>and $a_0 = \sqrt{\epsilon_w} - (a_1 \cdot \theta_w) = 1.58$</p> <p>$a_0 = 1.58$</p>
Result	<p>$a_1 = 9.00$</p> <p>$a_0 = 1.58$</p>

In this example this soil is now calibrated.

You can now use these two numbers in place of the standard mineral or organic calibration factors to convert SM150 readings into volumetric water content θ using:

$$\sqrt{\epsilon} = a_0 + a_1 \times \theta$$

See also page [Underlying principle](#) on page 39

Technical Support

Terms and Conditions of Sale

Our Conditions of Sale (ref: COND: 1/07) set out Delta-T's legal obligations on these matters. The following paragraphs summarise Delta T's position but reference should always be made to the exact terms of our Conditions of Sale, which will prevail over the following explanation.

Delta-T warrants that the goods will be free from defects arising out of the materials used or poor workmanship for a period of twelve months from the date of delivery.

Delta-T shall be under no liability in respect of any defect arising from fair wear and tear, and the warranty does not cover damage through misuse or inexpert servicing, or other circumstances beyond their control.

If the buyer experiences problems with the goods they shall notify Delta-T (or Delta-T's local distributor) as soon as they become aware of such problem.

Delta-T may rectify the problem by replacing faulty parts free of charge, or by repairing the goods free of charge at Delta-T's premises in the UK during the warranty period.

If Delta-T requires that goods under warranty be returned to them from overseas for repair, Delta-T shall not be liable for the cost of carriage or for customs clearance in respect of such goods. However, Delta-T requires that such returns are discussed with them in advance and may at their discretion waive these charges.

Delta-T shall not be liable to supply products free of charge or repair any goods where the products or goods in question have been discontinued or have become obsolete, although Delta-T will endeavour to remedy the buyer's problem.

Delta-T shall not be liable to the buyer for any consequential loss, damage or compensation whatsoever (whether caused by the negligence of the Delta-T, their employees or distributors or otherwise) which arise from the supply of the goods and/or services, or their use or resale by the buyer.

Delta-T shall not be liable to the buyer by reason of any delay or failure to perform their obligations in relation to the goods and/or services if the delay or failure was due to any cause beyond the Delta-T's reasonable control.

Service, Repairs and Spares

Users in countries that have a Delta-T distributor or technical representative should contact them in the first instance.

Spare parts for our own instruments can be supplied and can normally be despatched within a few working days of receiving an order.

Spare parts and accessories for products not manufactured by Delta-T may have to be obtained from our supplier, and a certain amount of additional delay is inevitable.

No goods or equipment should be returned to Delta-T without first obtaining the return authorisation from Delta-T or our distributor.

On receipt of the goods at Delta-T you will be given a reference number. Always refer to this reference number in any subsequent correspondence. The goods will be inspected and you will be informed of the likely cost and delay.

We normally expect to complete repairs within one or two weeks of receiving the equipment. However, if the equipment has to be forwarded to our original supplier for specialist repairs or recalibration, additional delays of a few weeks may be expected. For contact details see below.

Technical Support

Users in countries that have a Delta-T distributor or technical representative should contact them in the first instance.

Technical Support is available on Delta-T products and systems. Your initial enquiry will be acknowledged immediately with a reference number. Make sure to quote the reference number subsequently so that we can easily trace any earlier correspondence.

In your enquiry, always quote instrument serial numbers, software version numbers, and the approximate date and source of purchase where these are relevant.

Contact details:



Technical Support
Delta-T Devices Ltd
130 Low Road
Burwell
Cambridge CB25 0EJ
England (UK)

Tel: +44 1638 742922
Fax: +44 1638 743155
E-mail: tech.support@delta-t.co.uk
sales@delta-t.co.uk
Web: www.delta-t.co.uk

Index

A

Air reading, 29

C

Cable Connections, 10

Calibration, 22

check, 29

generalised, 26

sensor, 25, 26

soil, 23, 26

Soil, 39

soil-specific, 39

Care and safety, 8

Care and Safety, 8

Certification

emc, 35

Conductivity response, 31

Connections, 10, 14

Conversions

linearisation table, 24, 25

polynomial, 24, 25

Copyright, 2

D

Data logger, 18, 27, 28, 29

DL2e, 17, 27, 28

DL6, 16, 28

GP1, 14, 16, 28

other, 18

Definitions, 36

Description, 5

Dielectric

performance, 25

refractive index, 22, 23, 39

Dimensions, 6

DL6, 16

E

EMC, 35

Extension cables, 10

F

FCC compliance, 35

Features, 5

G

GP1, 14, 16, 28

H

HH150 meter, 12

HH2, 29

HH2 Meter, 13

I

Installation

buried, 11

insertion rod, 11

surface, 11

L

Linearisation table, 26

volts to %vol, 18, 27

Logger Grounding, 19

M

Moisture content, 5, 9, 38, 39

O

Organic and Mineral, 37

P

Parts, 7

Patent, 2

Permittivity, 9, 22, 38

Polynomial conversion, 26

R

References, 38

Regulatory information, 35

Rods, 8, 9, 11

S

Salinity, 37

Sampling Volume, 33

Servicing, 47

Soil

clay, 23, 24, 36, 39, 40, 43

mineral, 22, 24, 26, 40, 41, 44

organic, 22, 24, 26, 37, 41

stony, 11

soil calibrations, 24

Specifications, 2, 30

T

Technical support, 46, 47

Temperature response of soil moisture readings, 32

Troubleshooting, 28

V

Volumetric Soil Moisture, 36

W

Warning : Do not touch the pins, 29

Water reading, 29



Technical Support
Delta-T Devices Ltd
130 Low Road
Burwell
Cambridge CB25 0EJ
England (UK)

Tel: +44 1638 742922

Fax: +44 1638 743155

E-mail: tech.support@delta-t.co.uk
sales@delta-t.co.uk

Web: www.delta-t.co.uk